



LUMENIA
LIGHT SMARTER

LUMENIA INSPIRATION

KATALOG 22 / 23

KAZALO

DISCUS 7

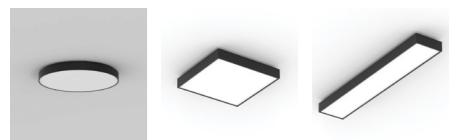

PLEXI ROUND 15

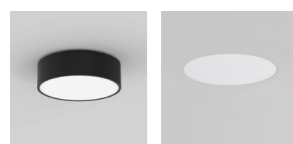

LUNA ROUND 27

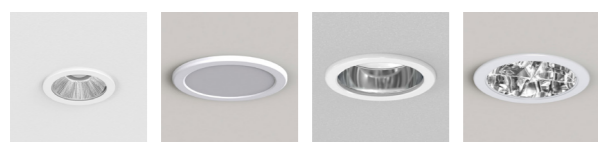

CYCLONE SLIM 37

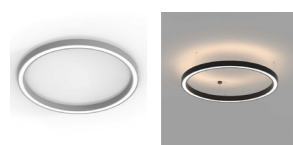

STORM 45



DION 61

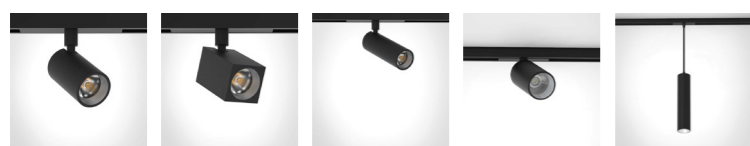

ROLLER 67



EASYLINE 81

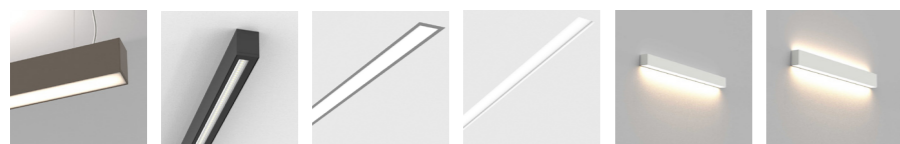

LEGENDA SIMBOLOV

PIKTOGRAMI

TESTNE OZNAKE

- izkoristek sistema
- IP20 - IP67 stopnja zaščite
- stopnja zaščite za vgradne svetilke
- priključna napetost
- odpornost na plamen in vžig
- odpornost na udarce
- vnetljivost
- IK00 - IK10 odpornost proti udarcem
- IECCE certifikat
- I. razred zaščite
- II. razred zaščite
- III. razred zaščite
- svetilka ne sme biti prekrita s toplotno izolacijo
- LED čip
- LED svetilka

- oznaka CE - označuje skladnost z ustreznimi EU smernicami
- testni znak EU in EFTE
- testni znak IMQ (Italija)

OSTALE OZNAKE

- 5-letna garancija
- sobna temperatura
- predstikalna naprava vključena
- predstikalna naprava ni vključena
- višina brez upoštevanja debeline materiala za spuščeni strop
- višina z upoštevanjem debeline materiala za spuščeni strop
- debelina materiala spuščene stropa
- dimenzija odprtine
- navpični kot nagiba
- vodoravni kot nagiba

NAČIN PRITRDITVE SVETILA

- stropna nadometna
- stropna vgradna
- stropna obešena
- stenska nadometna
- stenska nadometna z odmikom od stene
- stenska vgradna

NAČIN OSVETLITVE

- asimetrično
- ozek snop svetlobe
- srednje širok snop svetlobe
- širok snop svetlobe
- izredno širok difuzor žarka
- 'wallwasher'
- indirektno / direktno
- indirektno

BARVE

OSNOVNE BARVE

- RAL 9016 BELA / traffic white
- RAL 9006 TITAN / white aluminium
- RAL 9005 ČRNA / jet black

OSTALE BARVE

- RAL 7024 graphite grey
- RAL 7026 granite grey
- RAL 7030 stone grey
- RAL 7032 pebble grey
- RAL 7035 light grey
- RAL 7036 platinum grey
- RAL 7037 dusty grey
- RAL 7039 quartz grey

- RAL 7040 window grey
- RAL 7043 traffic grey B
- RAL 7047 telegrey 4
- RAL 7048 pearl mousse grey
- RAL 8007 fawn brown
- RAL 8014 sepia brown
- RAL 8015 chestnut brown
- RAL 8029 pearl copper
- RAL 9001 cream
- RAL 9002 grey white
- RAL 9007 grey aluminium
- RAL 9010 pure white
- RAL 9011 graphite black

POVRŠINSKE OBDELAVE

- krom
- mat aluminij
- eloksirano / anodizirano

O PODJETJU

LUMENIA razvija in izdeluje visoko kakovostne LED svetilke in rešitve za notranjo in zunanjo razsvetljavo. Vrhunska kvaliteta, prijaznost do okolja in energetska varčnost so zaščitni znak naših izdelkov.

Že več kot desetletje prisotnosti na trgu razsvetljave in že od vsega začetka nas vodi isti cilj: narediti življenje ljudi bolj prijetno, podjetja bolj produktivna in energetsko učinkovita, hkrati pa poskušati narediti svet bolj trajnostno naravn. To skušamo doseči z zasnovo visoko kakovostnih, sodobnih izdelkov, ki so prijazni okolju ter z majhno porabo energije.



Lastni razvoj in raziskave s fotometričnim in EMC laboratorijem.

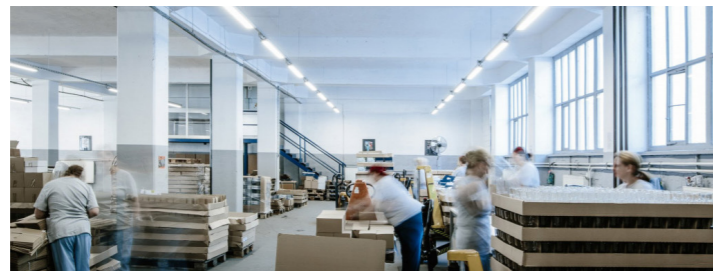

1.000m² SMD linije in 3.500m² proizvodnega dela.



Izrazito projektno naravnano podjetje.



Močna partnerska mreža na področju pametne razsvetljave.

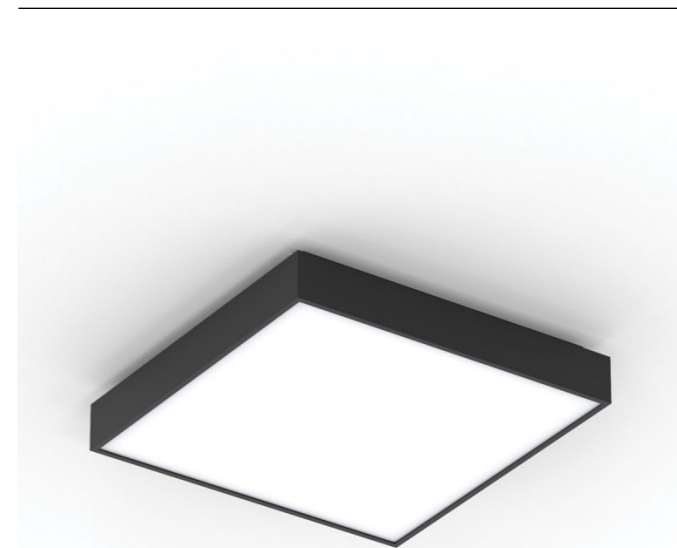
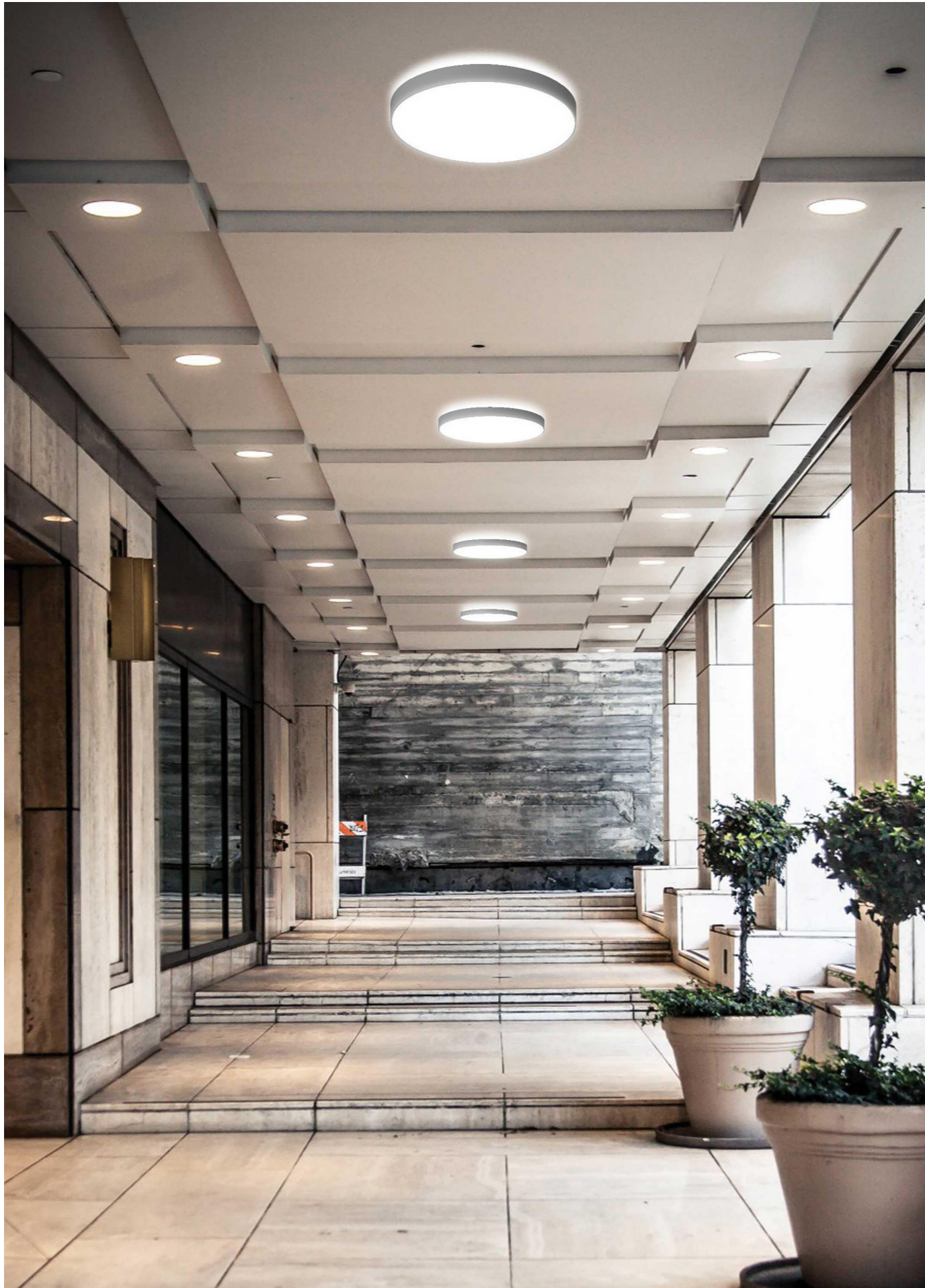

DISCUS je sodobno zasnovana svetilka krožne oblike. Zaradi enakomerne osvetlitve je primerna za osvetljevanje predverij, hodnikov, pisarn, trgovin in domov.

TEHNIČNI PODATKI IN LASTNOSTI

- Aluminijasto ohišje, prašno barvano v izbrani barvi.
- Izvedba z opalnim pleksi steklom ali mikroprizmatičnim pokrovom.
- Direktna in indirektna osvetlitev.
- Čista svetloba brez IR/UV sevanja.
- Učinkovito toplotno upravljanje.
- Življenjska doba delovanja:
50.000 ur z izkoristkom > 80% začetnega svetlobnega toka (L80B10).
- Prikluček za delovanje na 230V-50/60Hz.

NA ZAHTEVO

- Prikluček za sistem zasilne razsvetljave, za eno ali tri ure (za nekatere različice).

KARAKTERISTIKE



NAČIN PRITRDNITVE SVETILA



BARVE

- bela
- titan
- črna
- ostale barve

DISCUS



- Pokrov iz opalnega pleksi stekla.
- CRI: min. 80 / SDCM: 3

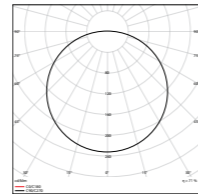
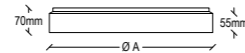

DISCUS 440

KODA PRODUKTA: 8261018X_
LED 3000K 35W 3900lm 113lm/W ØA 440mm

KODA PRODUKTA: 8261028X_
LED 4000K 35W 4100lm 118lm/W ØA 440mm

DISCUS 610

KODA PRODUKTA: 8261038X_
LED 3000K 60W 6800lm 115lm/W ØA 610mm

KODA PRODUKTA: 8261048X_
LED 4000K 60W 7200lm 121lm/W ØA 610mm

DISCUS 835

KODA PRODUKTA: 8261058X_
LED 3000K 98W 11700lm 120lm/W ØA 835mm

KODA PRODUKTA: 8261068X_
LED 4000K 98W 12300lm 126lm/W ØA 835mm



- Mikroprizmatični pokrov.
- CRI: min. 80 / SDCM: 3

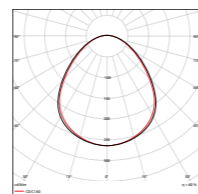
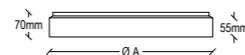

DISCUS 440 MICROPRISMATIC

KODA PRODUKTA: 8263018X_
LED 3000K 35W 3500lm 100lm/W ØA 440mm

KODA PRODUKTA: 8263028X_
LED 4000K 35W 3500lm 100lm/W ØA 440mm

DISCUS 610 MICROPRISMATIC

KODA PRODUKTA: 8263038X_
LED 3000K 60W 6000lm 100lm/W ØA 610mm

KODA PRODUKTA: 8263048X_
LED 4000K 60W 6100lm 102lm/W ØA 610mm

DISCUS 835 MICROPRISMATIC

KODA PRODUKTA: 8263058X_
LED 3000K 98W 9900lm 102lm/W ØA 835mm

KODA PRODUKTA: 8263068X_
LED 4000K 98W 10400lm 107lm/W ØA 835mm

DOPOLNITEV KODE PRODUKTA:

X = BARVA

ostale barve = 0 titan = 2
bela = 1 črna = 3

_ = D (dimmer)

Za svetilo z možnostjo zatemnitve (dimmer) dodajte črko D na koncu kode produkta.

DISCUS

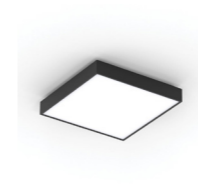

- Pokrov iz opalnega pleksi stekla.
- CRI: min. 80 / SDCM: 3

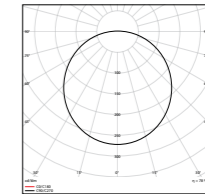
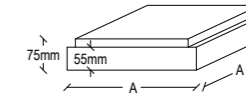

DISCUS Q

KODA PRODUKTA: 8321012X_
LED 3000K 22W 2200lm 100lm/W 295x295mm

KODA PRODUKTA: 8321013X_
LED 4000K 22W 2200lm 100lm/W 295x295mm

KODA PRODUKTA: 8321022X_
LED 3000K 29W 3200lm 113lm/W 390x390mm

KODA PRODUKTA: 8321023X_
LED 4000K 29W 3200lm 113lm/W 390x390mm

KODA PRODUKTA: 8321032X_
LED 3000K 33W 4700lm 145lm/W 640x640mm

KODA PRODUKTA: 8321033X_
LED 4000K 33W 4700lm 145lm/W 640x640mm

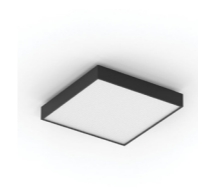

- Mikroprizmatični pokrov.
- CRI: min. 80 / SDCM: 3

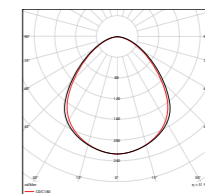
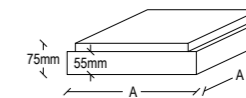

DISCUS Q MICROPRISMATIC

KODA PRODUKTA: 8323012X_
LED 3000K 22W 2200lm 100lm/W 295x295mm

KODA PRODUKTA: 8323013X_
LED 4000K 22W 2200lm 100lm/W 295x295mm

KODA PRODUKTA: 8323022X_
LED 3000K 29W 2900lm 100lm/W 390x390mm

KODA PRODUKTA: 8323023X_
LED 4000K 29W 2900lm 100lm/W 390x390mm

KODA PRODUKTA: 8323032X_
LED 3000K 33W 3690lm 120lm/W 640x640mm

KODA PRODUKTA: 8323033X_
LED 4000K 33W 3690lm 120lm/W 640x640mm

DOPOLNITEV KODE PRODUKTA:

X = BARVA

ostale barve = 0 titan = 2
bela = 1 črna = 3

_ = D (dimmer)

Za svetilo z možnostjo zatemnitve (dimmer) dodajte črko D na koncu kode produkta.

DISCUS



- Pokrov iz opalnega pleksi stekla.
- CRI: min. 80 / SDCM: 3

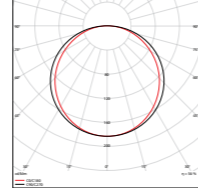
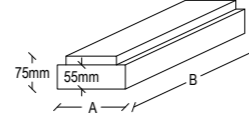

DISCUS PR

KODA PRODUKTA: 8321042X_
LED 3000K 25W 2500lm 100lm/W 220x640mm

KODA PRODUKTA: 8321043X_
LED 4000K 25W 2500lm 100lm/W 220x640mm

KODA PRODUKTA: 8321052X_
LED 3000K 25W 2500lm 100lm/W 160x900mm

KODA PRODUKTA: 8321053X_
LED 4000K 25W 2500lm 100lm/W 160x900mm

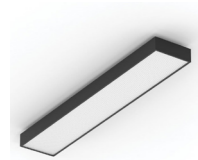

- Mikroprizmatični pokrov.
- CRI: min. 80 / SDCM: 3

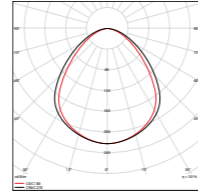
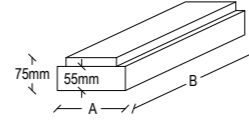

DISCUS PR MICROPRISMATIC

KODA PRODUKTA: 8323042X_
LED 3000K 25W 2500lm 100lm/W 220x640mm

KODA PRODUKTA: 8323043X_
LED 4000K 25W 2500lm 100lm/W 220x640mm

KODA PRODUKTA: 8323042X_
LED 3000K 25W 2500lm 100lm/W 160x900mm

KODA PRODUKTA: 8323043X_
LED 4000K 25W 2500lm 100lm/W 160x900mm

DOPOLNITEV KODE PRODUKTA:

X = BARVA _ = D (dimmer)

ostale barve = 0 titan = 2
bela = 1 črna = 3

Za svetilo z možnostjo zatemnitve (dimmer) dodajte črko D na koncu kode produkta.

DISCUS UP / DOWN



- Pokrov iz opalnega pleksi stekla.
- CRI: min. 80 / SDCM: 3

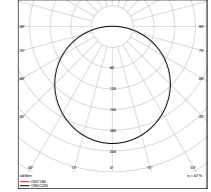
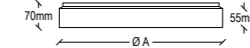

DISCUS UP/DOWN 440

KODA PRODUKTA: 8262018X_
LED 3000K 35W 3700lm 106lm/W ØA 440mm

KODA PRODUKTA: 8262028X_
LED 4000K 35W 3900lm 112lm/W ØA 440mm

DISCUS UP/DOWN 610

KODA PRODUKTA: 8262038X_
LED 3000K 60W 6400lm 108lm/W ØA 610mm

KODA PRODUKTA: 8262048X_
LED 4000K 60W 6800lm 114lm/W ØA 610mm



- Mikroprizmatični pokrov.
- CRI: min. 80 / SDCM: 3

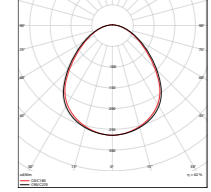
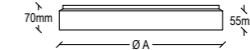
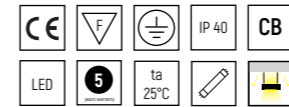

DISCUS UP/DOWN 440 MICROPRISMATIC

KODA PRODUKTA: 8264018X_
LED 3000K 35W 3500lm 100lm/W ØA 440mm

KODA PRODUKTA: 8264028X_
LED 4000K 35W 3700lm 107lm/W ØA 440mm

DISCUS UP/DOWN 610 MICROPRISMATIC

KODA PRODUKTA: 8264038X_
LED 3000K 60W 6000lm 100lm/W ØA 610mm

KODA PRODUKTA: 8264048X_
LED 4000K 60W 6500lm 109lm/W ØA 610mm

DOPOLNITEV KODE PRODUKTA:

X = BARVA _ = D (dimmer)

ostale barve = 0 titan = 2
bela = 1 črna = 3

Za svetilo z možnostjo zatemnitve (dimmer) dodajte črko D na koncu kode produkta.

DISCUS UP / DOWN

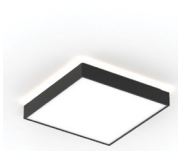

- Pokrov iz opalnega pleksi stekla.
- CRI: min. 80 / SDCM: 3

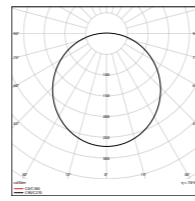
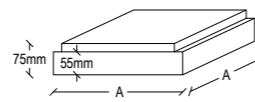
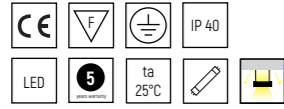

DISCUS Q UP/DOWN

KODA PRODUKTA: 8322012X_
LED 3000K 22W 2200lm 100lm/W 295x295mm

KODA PRODUKTA: 8322013X_
LED 4000K 22W 2200lm 100lm/W 295x295mm

KODA PRODUKTA: 8322022X_
LED 3000K 29W 3190lm 110lm/W 390x390mm

KODA PRODUKTA: 8322023X_
LED 4000K 29W 3190lm 110lm/W 390x390mm

KODA PRODUKTA: 8322032X_
LED 3000K 33W 4400lm 136lm/W 640x640mm

KODA PRODUKTA: 8322033X_
LED 4000K 33W 4800lm 148lm/W 640x640mm

DISCUS UP / DOWN



- Pokrov iz opalnega pleksi stekla.
- CRI: min. 80 / SDCM: 3

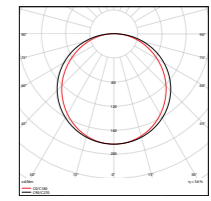
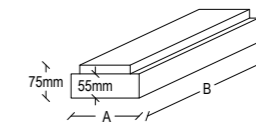
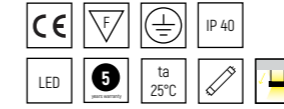

DISCUS PR UP/DOWN

KODA PRODUKTA: 8322042X_
LED 3000K 25W 2500lm 100lm/W 220x640mm

KODA PRODUKTA: 8322043X_
LED 4000K 25W 2500lm 100lm/W 220x640mm

KODA PRODUKTA: 8322052X_
LED 3000K 25W 2500lm 100lm/W 160x900mm

KODA PRODUKTA: 8322053X_
LED 4000K 25W 2500lm 100lm/W 160x900mm

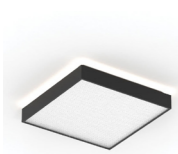

- Mikroprizmatični pokrov.
- CRI: min. 80 / SDCM: 3

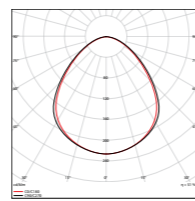
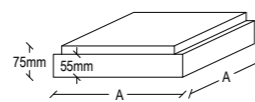
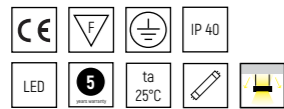

DISCUS Q UP/DOWN MICROPRISMATIC

KODA PRODUKTA: 8324012X_
LED 3000K 22W 2200lm 100lm/W 295x295mm

KODA PRODUKTA: 8324013X_
LED 4000K 22W 2200lm 100lm/W 295x295mm

KODA PRODUKTA: 8324022X_
LED 3000K 29W 3190lm 110lm/W 390x390mm

KODA PRODUKTA: 8324023X_
LED 4000K 29W 3190lm 110lm/W 390x390mm

KODA PRODUKTA: 8324032X_
LED 3000K 33W 4400lm 136lm/W 640x640mm

KODA PRODUKTA: 8324033X_
LED 4000K 33W 4800lm 148lm/W 640x640mm



- Mikroprizmatični pokrov.
- CRI: min. 80 / SDCM: 3

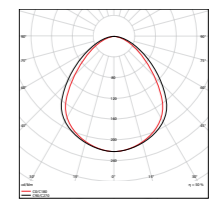
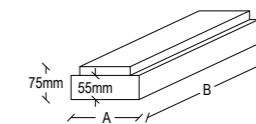
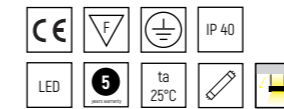

DISCUS PR UP/DOWN MICROPRISMATIC

KODA PRODUKTA: 8324042X_
LED 3000K 25W 2500lm 100lm/W 220x640mm

KODA PRODUKTA: 8324043X_
LED 4000K 25W 2500lm 100lm/W 220x640mm

KODA PRODUKTA: 8324042X_
LED 3000K 25W 2500lm 100lm/W 160x900mm

KODA PRODUKTA: 8324043X_
LED 4000K 25W 2500lm 100lm/W 160x900mm

DOPOLNITEV KODE PRODUKTA:

X = BARVA

ostale barve = 0
bela = 1

titan = 2
črna = 3

_ = D (dimmer)

Za svetilo z možnostjo zatemnitve (dimmer) dodajte črko D na koncu kode produkta.

DOPOLNITEV KODE PRODUKTA:

X = BARVA

ostale barve = 0
bela = 1

titan = 2
črna = 3

_ = D (dimmer)

Za svetilo z možnostjo zatemnitve (dimmer) dodajte črko D na koncu kode produkta.



PLEXI ROUND



PLEXI ROUND je sodobno zasnovana svetilka krožne oblike. Zaradi enakomerne osvetlitve je primerna za osvetljevanje preddverij, hodnikov, pisarn, trgovin in domov. Na voljo je v naslednjih premerih: 300, 350, 450, 620 in 900 mm.

TEHNIČNI PODATKI IN LASTNOSTI

- Aluminijasto ohišje, prašno barvano v izbrani barvi.
- Izvedba z opalnim pleksi steklom ali mikroprizmatičnim pokrovom.
- Direkna osvetlitev.
- Čista svetloba brez IR/UV sevanja.
- Učinkovito toplotno upravljanje.
- Življenjska doba delovanja: 50.000 ur z izkoristkom > 80 % začetnega svetlobnega toka (L80B10).
- Prikluček za delovanje na 230V-50/60Hz.
- Na voljo z možnostjo zatemnitve.
- Na voljo kot stropno ali viseče svetilo.

NA ZAHTEVO

- Prikluček za sistem zasilne razsvetljave, za eno ali tri ure.
- Na voljo v večjih dimenzijah.

KARAKTERISTIKE

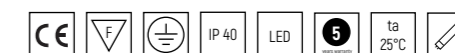

NAČIN PRITRDITVE SVETILA



BARVE

- bela
- titan
- črna
- ostale barve

PLEXI ROUND



- Pokrov iz opalnega pleksi stekla.
- CRI: min. 80 / SDCM: 3

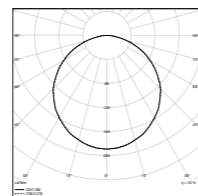
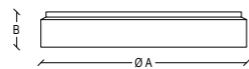

Ø 300mm

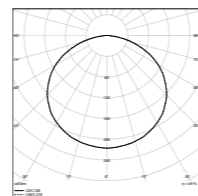

Ø 900mm

PLEXI ROUND 300

KODA PRODUKTA: 8231098X_
LED 3000K 20W 2000lm 100lm/W ØA 300mm, B 140mm

KODA PRODUKTA: 8231108X_
LED 4000K 20W 2000lm 100lm/W ØA 300mm, B 140mm

PLEXI ROUND 350

KODA PRODUKTA: 8231138X_
LED 3000K 20W 2000lm 100lm/W ØA 350mm, B 140mm

KODA PRODUKTA: 8231148X_
LED 4000K 20W 2000lm 100lm/W ØA 350mm, B 140mm

PLEXI ROUND 450

KODA PRODUKTA: 8231078X_
LED 3000K 24W 2500lm 105lm/W ØA 450mm, B 140mm

KODA PRODUKTA: 8231088X_
LED 4000K 24W 2600lm 110lm/W ØA 450mm, B 140mm

PLEXI ROUND 620

KODA PRODUKTA: 8231118X_
LED 3000K 60W 6400lm 107lm/W ØA 620mm, B 140mm

KODA PRODUKTA: 8231128X_
LED 4000K 60W 6600lm 111lm/W ØA 620mm, B 140mm

PLEXI ROUND 900

KODA PRODUKTA: 8231158X_
LED 3000K 110W 12000lm 110lm/W ØA 900mm, B 140mm

KODA PRODUKTA: 8231168X_
LED 4000K 110W 12500lm 114lm/W ØA 900mm, B 140mm

PLEXI ROUND



- Mikroprizmatični pokrov.
- CRI: min. 80 / SDCM: 3

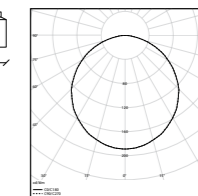
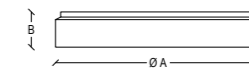

Ø 300mm

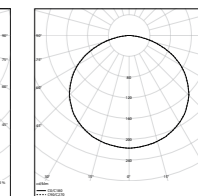

Ø 900mm

PLEXI ROUND 300 MICROPRISMATIC

KODA PRODUKTA: 8235098X_
LED 3000K 20W 2000lm 100lm/W ØA 300mm, B 140mm

KODA PRODUKTA: 8235108X_
LED 4000K 20W 2000lm 100lm/W ØA 300mm, B 140mm

PLEXI ROUND 350 MICROPRISMATIC

KODA PRODUKTA: 8235138X_
LED 3000K 20W 2000lm 100lm/W ØA 350mm, B 140mm

KODA PRODUKTA: 8235148X_
LED 4000K 20W 2000lm 100lm/W ØA 350mm, B 140mm

PLEXI ROUND 450 MICROPRISMATIC

KODA PRODUKTA: 8235078X_
LED 3000K 24W 2500lm 105lm/W ØA 450mm, B 140mm

KODA PRODUKTA: 8235088X_
LED 4000K 24W 2600lm 110lm/W ØA 450mm, B 140mm

PLEXI ROUND 620 MICROPRISMATIC

KODA PRODUKTA: 8235118X_
LED 3000K 60W 6400lm 107lm/W ØA 620mm, B 140mm

KODA PRODUKTA: 8235128X_
LED 4000K 60W 6600lm 111lm/W ØA 620mm, B 140mm

PLEXI ROUND 900 MICROPRISMATIC

KODA PRODUKTA: 8235158X_
LED 3000K 110W 12000lm 110lm/W ØA 900mm, B 140mm

KODA PRODUKTA: 8235168X_
LED 4000K 110W 12500lm 114lm/W ØA 900mm, B 140mm



- Kabel in regulatorji iz nerjavečega jekla.
- Z aluminijasto rozeto Ø 125 mm
in s prozornim kablom.



NASTAVLJIVO OBEŠALO

KODA PRODUKTA: 80231X
3x0,75mm² L=2000mm 0,300kg

KODA PRODUKTA: 80232X
3x0,75mm² L=3000mm 0,300kg

KODA PRODUKTA: 80233X
5x0,50mm² L=2000mm 0,300kg

KODA PRODUKTA: 80234X
5x0,50mm² L=3000mm 0,300kg

DOPOLNITEV KODE PRODUKTA:

X = BARVA

ostale barve = 0 titan = 2
bela = 1 črna = 3

_ = D (dimmer)

Za svetilo z možnostjo zatemnitve (dimmer)
dodajte črko D na koncu kode produkta.

DOPOLNITEV KODE PRODUKTA:

X = BARVA

ostale barve = 0 titan = 2
bela = 1 črna = 3

_ = D (dimmer)

Za svetilo z možnostjo zatemnitve (dimmer)
dodajte črko D na koncu kode produkta.



PLEXI ROUND TRIMLESS



PLEXI ROUND TRIMLESS je sodobno zasnovana, vgradna svetilka krožne oblike. Zaradi enakomerne osvetlitve je primerna za osvetljevanje preddverij, hodnikov, pisarn, trgovin in domov.
Na voljo je v naslednjih premerih: 300, 350, 450, 620, 900 in 1200mm.

KARAKTERISTIKE

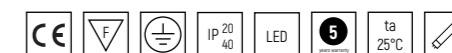

TEHNIČNI PODATKI IN LASTNOSTI

- Aluminijasto ohišje, prašno barvano v izbrani barvi.
- Izvedba z opalnim pleksi steklom ali mikroprizmatičnim pokrovom.
- Enostavna montaža.
- Čista svetloba brez IR/UV sevanja.
- Učinkovito toplotno upravljanje.
- Življenjska doba delovanja:
 - 50.000 ur z izkoristkom > 80 % začetnega svetlobnega toka (L80B10).
- Priključek za delovanje na 230V-50/60Hz.
- Na voljo z možnostjo zatemnitve.
- Vgradna svetilka.

NAČIN PRITRDNITVE SVETILA



NA ZAHTEVO

- Priključek za sistem zasilne razsvetljave, za eno ali tri ure.

PLEXI ROUND TRIMLESS



- Pokrov iz opalnega pleksi stekla.
- Obešalo vključeno.
- CRI: min. 80 / SDCM: 3

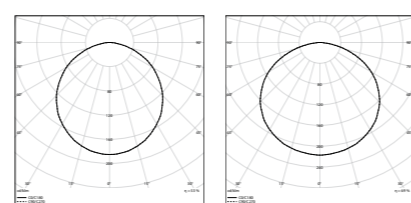
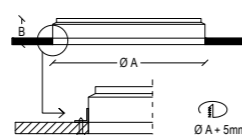

Ø 300mm Ø 900mm

PLEXI ROUND 300 TRIMLESS

KODA PRODUKTA: 82330981_
LED 3000K 20W 2000lm 100lm/W ØA 300mm, B 140mm

KODA PRODUKTA: 82331081_
LED 4000K 20W 2000lm 100lm/W ØA 300mm, B 140mm

PLEXI ROUND 350 TRIMLESS

KODA PRODUKTA: 82331381_
LED 3000K 20W 2000lm 100lm/W ØA 350mm, B 140mm

KODA PRODUKTA: 82331481_
LED 4000K 20W 2000lm 100lm/W ØA 350mm, B 140mm

PLEXI ROUND 450 TRIMLESS

KODA PRODUKTA: 82330781_
LED 3000K 24W 2400lm 100lm/W ØA 450mm, B 120mm

KODA PRODUKTA: 82330881_
LED 4000K 24W 2400lm 103lm/W ØA 450mm, B 120mm

PLEXI ROUND 620 TRIMLESS

KODA PRODUKTA: 82331181_
LED 3000K 60W 5600lm 95lm/W ØA 620mm, B 120mm

KODA PRODUKTA: 82331281_
LED 4000K 60W 5900lm 98lm/W ØA 620mm, B 120mm

PLEXI ROUND 900 TRIMLESS

KODA PRODUKTA: 82331581_
LED 3000K 110W 12700lm 116lm/W ØA 900mm, B 120mm

KODA PRODUKTA: 82331681_
LED 4000K 110W 13200lm 120lm/W ØA 900mm, B 120mm

PLEXI ROUND 1200 TRIMLESS

KODA PRODUKTA: 82331781_
LED 3000K 135W 12000lm 110lm/W ØA 1200mm, B 120mm

KODA PRODUKTA: 82331881_
LED 4000K 135W 12500lm 114lm/W ØA 1200mm, B 120mm

DOPOLNITEV KODE PRODUKTA:

_ = D (dimmer)

Za svetilo z možnostjo zatemnitve (dimmer) dodajte črko D na koncu kode produkta.

PLEXI ROUND TRIMLESS



- Mikroprizmatični pokrov.
- Vzmetenja vključeni.
- CRI: min. 80 / SDCM: 3

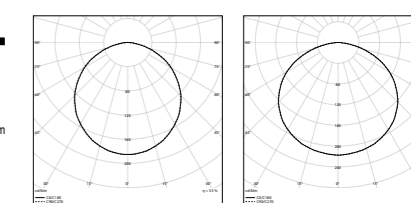
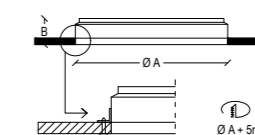

Ø 300mm Ø 900mm

PLEXI ROUND 300 MICROPRISMATIC TRIMLESS

KODA PRODUKTA: 82370981_
LED 3000K 20W 2000lm 100lm/W ØA 300mm, B 140mm

KODA PRODUKTA: 82371081_
LED 4000K 20W 2000lm 100lm/W ØA 300mm, B 140mm

PLEXI ROUND 350 MICROPRISMATIC TRIMLESS

KODA PRODUKTA: 82371381_
LED 3000K 20W 2000lm 100lm/W ØA 350mm, B 145mm

KODA PRODUKTA: 82371481_
LED 4000K 20W 2000lm 100lm/W ØA 350mm, B 145mm

PLEXI ROUND 450 MICROPRISMATIC TRIMLESS

KODA PRODUKTA: 82370781_
LED 3000K 24W 2400lm 100lm/W ØA 450mm, B 120mm

KODA PRODUKTA: 82370881_
LED 4000K 24W 2400lm 103lm/W ØA 450mm, B 120mm

DOPOLNITEV KODE PRODUKTA:

_ = D (dimmer)

Za svetilo z možnostjo zatemnitve (dimmer) dodajte črko D na koncu kode produkta.



PLEXI ROUND HIGH



PLEXI ROUND HIGH je sodobno zasnovana svetilka krožne oblike. Zaradi enakomerne osvetlitve je primerna za osvetljevanje preddverij, hodnikov, pisarn, trgovin in domov. Na voljo je v naslednjih premerih: 1200 in 1500mm.

TEHNIČNI PODATKI IN LASTNOSTI

- Aluminijasto ohišje, prašno barvano v izbrani barvi.
- Pokrov iz opalnega pleksi stekla.
- Direkna ali indirektna osvetlitev. Čista svetloba brez IR/UV sevanja.
- Učinkovito toplotno upravljanje.
- Življenjska doba delovanja: 50.000 ur z izkoristkom > 80 % začetnega svetlobnega toka (L80B10).
- Priključek za delovanje na 230V-50/60Hz.
- Na voljo z možnostjo zatemnitve.
- Na voljo kot stropno ali viseče svetilo.

NA ZAHTEVO

- Priključek za delovanje z modulom zasilne razsvetljave.
- Na voljo v različici gor/dol.

KARAKTERISTIKE



NAČIN PRITRDNITVE SVETILA



BARVE

- bela
- titan
- črna
- ostale barve

PLEXI ROUND HIGH



- Visoko učinkovit pokrov iz opalnega pleksi stekla.
- CRI: min. 80 / SDCM: 3

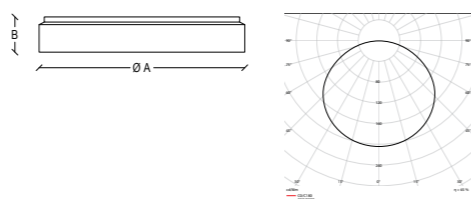

PLEXI ROUND HIGH 1200

KODA PRODUKTA: 8231178X_
LED 3000K 175W 19250lm 110lm/W ØA 1200mm, B 230mm

KODA PRODUKTA: 8231188X_
LED 4000K 175W 19250lm 110lm/W ØA 1200mm, B 230mm

PLEXI ROUND HIGH 1500

KODA PRODUKTA: 8231198X_
LED 3000K 270W 31700lm 117lm/W ØA 1500mm, B 230mm

KODA PRODUKTA: 8231208X_
LED 4000K 270W 31700lm 117lm/W ØA 1500mm, B 230mm

DOPOLNITEV KODE PRODUKTA:

X = BARVA

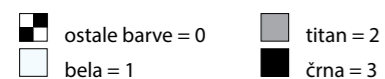

_ = D (dimmer)

Za svetilo z možnostjo zatemnitve (dimmer) dodajte črko D na koncu kode produkta.





LUNA ROUND



Svetilo LUNA ROUND je primerno je za osvetljevanje prostorov, kjer je potrebna razpršena svetloba.

TEHNIČNI PODATKI IN LASTNOSTI

- Zunanji obroč iz tlačno litega aluminija, prevlečen ali prašno barvan v izbrani barvi.
- Zunanji obroč iz tlačno litega aluminija ali jekla vrste 235, prevlečen ali prašno barvan v izbrani barvi.
- Notranje ohišje iz tlačno litega aluminija.
- Elokisirani reflektorji iz visoko čistega aluminija.
- Križno oblikovana lamela brez preliva s paraboličnimi rezili izdelan iz čistega aluminija.
- Posebna izdaja z visokim reflektorjem proti bleščanju.
- Podpora stropu z vzmetmi.
- Čista svetloba brez IR/UV sevanja.
- Elokisirano hladilno telo iz litega aluminija.
- Učinkovito toplotno upravljanje.
- Življenjska doba delovanja: 50.000 ur z izkoristkom > 80 % začetnega svetlobnega toka (L80B10).
- Priključek za delovanje s konstantnim tokom.
- Vgradni reflektorji.

NA ZAHTEVO

- Na voljo z višjim indeksom barvnega upodabljanja (CRI).

KARAKTERISTIKE



NAČIN PRITRDNITVE SVETILA



BARVE

- bela
- titan
- črna
- ostale barve

POVRŠINSKE OBDELAVE

- krom
- mat aluminij

LUNA ROUND



- Različica za LED ČIP.
- Notranje ohišje iz tlačno litega aluminija.
- CRI: min. 80 / SDCM: 3

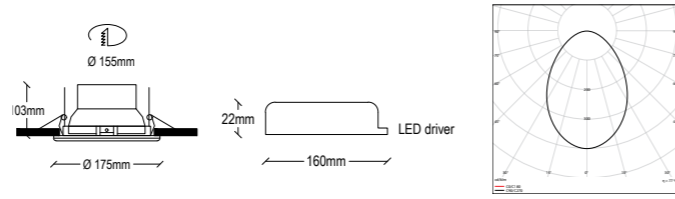
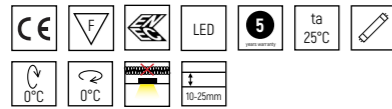

LUNA ROUND 175 LED

KODA PRODUKTA: 465321_
LED 3000K 19W 2100lm 111lm/W Ø 175mm 0,830kg

KODA PRODUKTA: 465331_
LED 4000K 19W 2200lm 119lm/W Ø 175mm 0,830kg

KODA PRODUKTA: 465323_
LED 3000K 26W 2860lm 110lm/W Ø 175mm 1,000kg

KODA PRODUKTA: 465333_
LED 4000K 26W 2860lm 110lm/W Ø 175mm 1,000kg



- Zunanji obroč iz tlačno litega aluminija.
- Pokrov PMMA iz peskanega metakrilata.



LUNA ROUND 175 ZUNANJI OBROČ

KODA PRODUKTA: 40024X
IP43 Ø 175mm 0,120kg

KODA PRODUKTA: 40018X
IP54 Ø 175mm 0,120kg

DOPOLNITEV KODE PRODUKTA:

X = BARVA

ostale barve = 0 titan = 2 krom = 4
bela = 1 črna = 3 mat aluminij = 5

_ = D (dimmer)

Za svetilo z možnostjo zatemnitve (dimmer) dodajte črko D na koncu kode produkta.

LUNA ROUND



- Različica za LED ČIP.
- Notranje ohišje iz tlačno litega aluminija.
- CRI: min. 80 / SDCM: 3

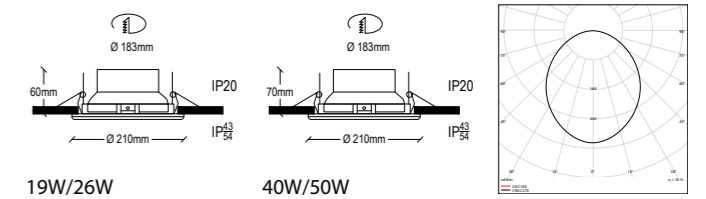
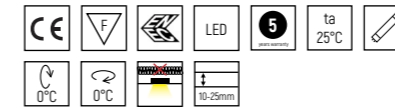

LUNA ROUND 210 LED CHIP

KODA PRODUKTA: 466622_
LED 3000K 19W 2100lm 111lm/W Ø 210mm 0,950kg

KODA PRODUKTA: 466623_
LED 4000K 19W 2250lm 119lm/W Ø 210mm 0,950kg

KODA PRODUKTA: 466632_
LED 3000K 26W 2800lm 109lm/W Ø 210mm 0,950kg

KODA PRODUKTA: 466633_
LED 4000K 26W 3000lm 117lm/W Ø 210mm 0,950kg

KODA PRODUKTA: 466642_
LED 3000K 40W 4000lm 100lm/W Ø 210mm 1,000kg

KODA PRODUKTA: 466643_
LED 4000K 40W 4290lm 107lm/W Ø 210mm 1,000kg

KODA PRODUKTA: 466652_
LED 3000K 50W 6180lm 124lm/W Ø 210mm 1,000kg

KODA PRODUKTA: 466653_
LED 4000K 50W 6300lm 127lm/W Ø 210mm 1,000kg



- Zunanji obroč iz tlačno litega aluminija.
- Pokrov PMMA iz peskanega metakrilata.



LUNA ROUND 210 ZUNANJI OBROČ

KODA PRODUKTA: 40029X
IP43 Ø 210mm 0,180kg

KODA PRODUKTA: 40019X
IP54 Ø 210mm 0,220kg

DOPOLNITEV KODE PRODUKTA:

X = BARVA

ostale barve = 0 titan = 2 krom = 4
bela = 1 črna = 3 mat aluminij = 5

_ = D (dimmer)

Za svetilo z možnostjo zatemnitve (dimmer) dodajte črko D na koncu kode produkta.

LUNA ROUND



- Različica za LED ČIP.
- Notranje ohišje iz tlačno litega aluminija.
- Zunanji obroč iz tlačno litega aluminija.
- Pokrov PMMA iz peskanega metakrilata.
- Brez bleščanja.
- CRI: min. 80 / SDCM: 3

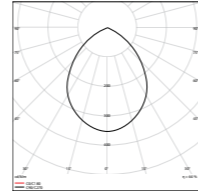
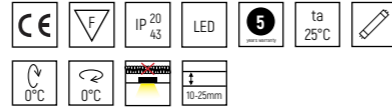

LUNA ROUND 210 MV LED CHIP

KODA PRODUKTA: 4667012X_	LED 3000K	19W	1900lm	100lm/W	Ø 210mm	1,000kg
KODA PRODUKTA: 4667013X_	LED 4000K	19W	1900lm	100lm/W	Ø 210mm	1,000kg
KODA PRODUKTA: 4667022X_	LED 3000K	26W	2600lm	100lm/W	Ø 210mm	1,000kg
KODA PRODUKTA: 4667023X_	LED 4000K	26W	2600lm	100lm/W	Ø 210mm	1,000kg
KODA PRODUKTA: 4667032X_	LED 3000K	40W	4000lm	100lm/W	Ø 210mm	1,100kg
KODA PRODUKTA: 4667033X_	LED 4000K	40W	4000lm	100lm/W	Ø 210mm	1,100kg
KODA PRODUKTA: 4667042X_	LED 3000K	50W	5100lm	103lm/W	Ø 210mm	1,100kg
KODA PRODUKTA: 4667043X_	LED 3000K	50W	5300lm	106lm/W	Ø 210mm	1,100kg

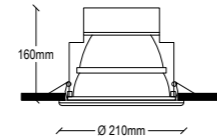

- Različica za LED ČIP.
- Notranje ohišje iz tlačno litega aluminija.
- Zunanji jekleni obroč.
- Brez bleščanja.
- CRI: min. 80 / SDCM: 3

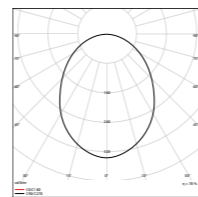
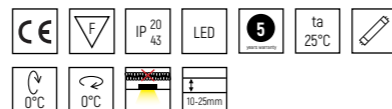

LUNA ROUND 235 LED CHIP

KODA PRODUKTA: 45532X_	LED 3000K	19W	2100lm	113lm/W	Ø 235mm	1,000kg
KODA PRODUKTA: 45533X_	LED 4000K	19W	2250lm	121lm/W	Ø 235mm	1,000kg
KODA PRODUKTA: 45512X_	LED 3000K	26W	2900lm	112lm/W	Ø 235mm	1,000kg
KODA PRODUKTA: 45513X_	LED 4000K	26W	3100lm	120lm/W	Ø 235mm	1,000kg

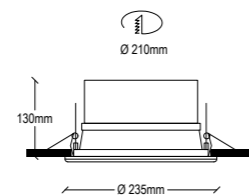

DOPOLNITEV KODE PRODUKTA:

X = BARVA

ostale barve = 0	titan = 2	krom = 4
bela = 1	črna = 3	mat aluminij = 5

_ = D (dimmer)

Za svetilo z možnostjo zatemnitve (dimmer) dodajte črko D na koncu kode produkta.

LUNA ROUND

KODA PRODUKTA: 45542X_	LED 3000K	40W	4100lm	103lm/W	Ø 235mm	1,000kg
------------------------	-----------	-----	--------	---------	---------	---------

KODA PRODUKTA: 45543X_	LED 4000K	40W	4400lm	111lm/W	Ø 235mm	1,000kg
------------------------	-----------	-----	--------	---------	---------	---------

KODA PRODUKTA: 45522X_	LED 3000K	50W	6000lm	120lm/W	Ø 235mm	1,500kg
------------------------	-----------	-----	--------	---------	---------	---------

KODA PRODUKTA: 45523X_	LED 4000K	50W	6400lm	129lm/W	Ø 235mm	1,500kg
------------------------	-----------	-----	--------	---------	---------	---------



- Različica za LED ČIP.
- Notranje ohišje iz tlačno litega aluminija.
- Zunanji jekleni obroč.
- Brez bleščanja.
- CRI: min. 80 / SDCM: 3

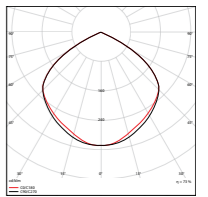
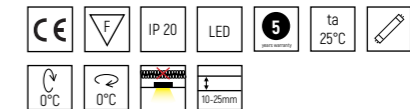

LUNA ROUND 235 CROSS LED CHIP

KODA PRODUKTA: 46452X_	LED 3000K	19W	2000lm	106lm/W	Ø 235mm	1,000kg
------------------------	-----------	-----	--------	---------	---------	---------

KODA PRODUKTA: 46453X_	LED 4000K	19W	2100lm	113lm/W	Ø 235mm	1,000kg
------------------------	-----------	-----	--------	---------	---------	---------

KODA PRODUKTA: 46442X_	LED 3000K	26W	2700lm	105lm/W	Ø 235mm	1,000kg
------------------------	-----------	-----	--------	---------	---------	---------

KODA PRODUKTA: 46443X_	LED 4000K	26W	2900lm	112lm/W	Ø 235mm	1,000kg
------------------------	-----------	-----	--------	---------	---------	---------

KODA PRODUKTA: 46462X_	LED 3000K	40W	4000lm	100lm/W	Ø 235mm	1,100kg
------------------------	-----------	-----	--------	---------	---------	---------

KODA PRODUKTA: 46463X_	LED 4000K	40W	4000lm	100lm/W	Ø 235mm	1,100kg
------------------------	-----------	-----	--------	---------	---------	---------

KODA PRODUKTA: 46472X_	LED 3000K	50W	5550lm	112lm/W	Ø 235mm	1,100kg
------------------------	-----------	-----	--------	---------	---------	---------

KODA PRODUKTA: 46473X_	LED 4000K	50W	5700lm	115lm/W	Ø 235mm	1,100kg
------------------------	-----------	-----	--------	---------	---------	---------

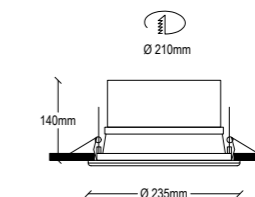

DOPOLNITEV KODE PRODUKTA:

X = BARVA

ostale barve = 0	titan = 2	krom = 4
bela = 1	črna = 3	mat aluminij = 5

_ = D (dimmer)

Za svetilo z možnostjo zatemnitve (dimmer) dodajte črko D na koncu kode produkta.



LUNA ROUND ECO



LUNA ROUND ECO je sodobno zasnovana vgradna downlight svetilka. Primerna je za osvetljevanje različnih vrst prostorov, zasebnih in javnih, kot so trgovine, hoteli, razstave, muzeji, ipd.

KARAKTERISTIKE



TEHNIČNI PODATKI IN LASTNOSTI

- Jekleno ohišje, prašno barvano.
- Aluminijasti reflektor s kotom osvetlitve 60° ali 90°.
- Zunanji obroč iz PMMA pri lakirani izvedbi ali iz aluminija pri prevlečeni izvedbi.
- Čista svetloba brez IR/UV sevanja.
- Učinkovito toplotno upravljanje.
- Življenjska doba delovanja: 50.000 ur z izkoristkom > 70 % začetnega svetlobnega toka (L70B50).
- Vgradna svetilka.

NAČIN PRITRDNITVE SVETILA



NAČIN OSVETLITVE



BARVE

- bela
- titan
- črna
- ostale barve

POVRŠINSKE OBDELAVE

- krom
- mat aluminj

LUNA ROUND ECO



- Različica za LED ČIP.
- Zunanji obroč iz PMMA za barvane izvedbe ali aluminij za prevlečene različice.
- Aluminijasti reflektor s PMMA pokrovom.
- Priložen napajalni modul 230V/50Hz.
- Reflektor s kotom osvetlitve 60° ali 90°.
- CRI: min. 80 / SDCM: 4

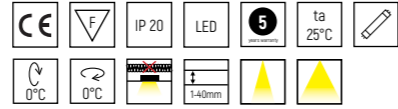

LUNA ROUND 125 LED ECO MINI

KODA PRODUKTA: 46572X1	LED 3000K	10W	1000lm	104lm/W	60°	Ø 125mm	0,200kg
KODA PRODUKTA: 46573X1	LED 4000K	10W	1100lm	109lm/W	60°	Ø 125mm	0,200kg
KODA PRODUKTA: 46572X	LED 3000K	10W	1000lm	103lm/W	90°	Ø 125mm	0,200kg
KODA PRODUKTA: 46573X	LED 4000K	10W	1100lm	108lm/W	90°	Ø 125mm	0,200kg

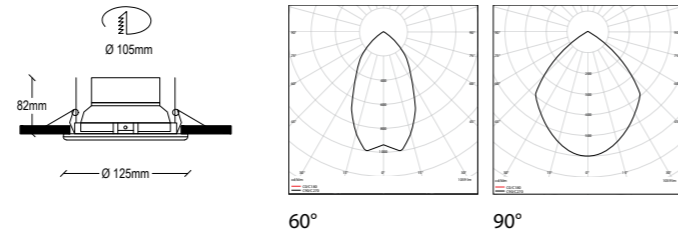

LUNA ROUND 175 LED ECO MINI

KODA PRODUKTA: 46562X1	LED 3000K	20W	2100lm	105lm/W	60°	Ø 175mm	0,450kg
KODA PRODUKTA: 46563X1	LED 4000K	20W	2200lm	109lm/W	60°	Ø 175mm	0,450kg
KODA PRODUKTA: 46562X	LED 3000K	20W	2100lm	105lm/W	90°	Ø 175mm	0,450kg
KODA PRODUKTA: 46563X	LED 4000K	20W	2200lm	109lm/W	90°	Ø 175mm	0,450kg

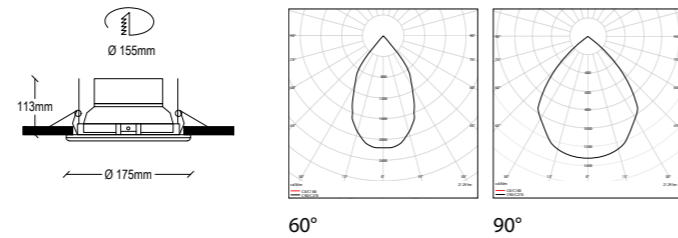

LUNA ROUND 225 LED ECO MINI

KODA PRODUKTA: 46582X1	LED 3000K	30W	3000lm	103lm/W	60°	Ø 225mm	0,600kg
KODA PRODUKTA: 46583X1	LED 4000K	30W	3150lm	107lm/W	60°	Ø 225mm	0,600kg
KODA PRODUKTA: 46582X	LED 3000K	30W	3000lm	103lm/W	90°	Ø 225mm	0,600kg
KODA PRODUKTA: 46583X	LED 4000K	30W	3150lm	107lm/W	90°	Ø 225mm	0,600kg

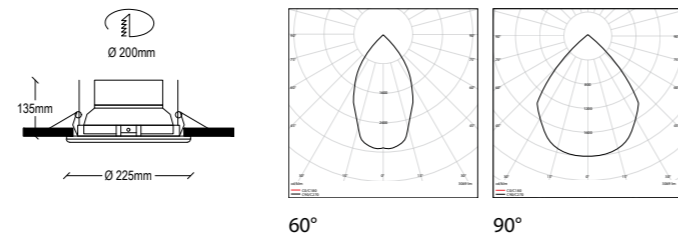

DOPOLNITEV KODE PRODUKTA:

X = BARVA

ostale barve = 0	titan = 2	krom = 4
bela = 1	črna = 3	mat aluminij = 5

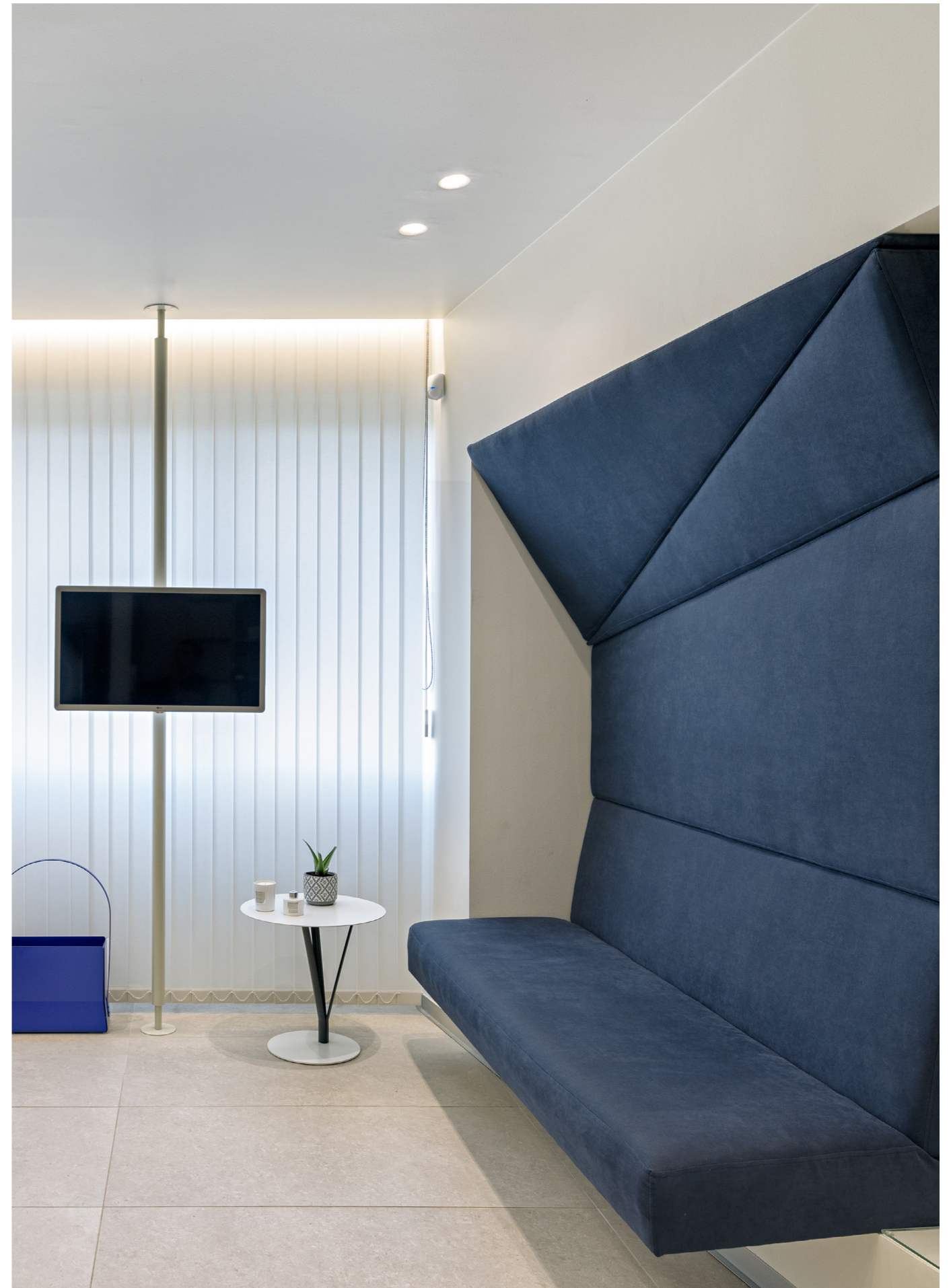



CYCLONE SLIM



CYCLONE SLIM svetilko odlikuje njena učinkovitost ter sodoben izgled. Ustvarja popolne svetlobne pogoje brez neprijetnih odsevov, zato je poleg osvetljevanja prostorov večjih dimenzij, kot so avle, muzeji, restavracije, ipd., primerna tudi za uporabo na delovnih mestih. Zaradi sistema nizanja (continuous-row system) je osvetljenost popolnoma enakomerna od začetka do konca. Svetilo je ekonomsko učinkovito, ne potrebuje vzdrževanja in ima dolgotrajno življenjsko dobo.

KARAKTERISTIKE



NAČIN PRITRDNITVE SVETILA



BARVE

- bela
- titan
- črna
- ostale barve

TEHNIČNI PODATKI IN LASTNOSTI

- Aluminijasto ohišje, prašno barvano v izbrani barvi.
- Visoko učinkovita satenasta prevleka.
- Neposredna osvetlitev.
- Čista svetloba brez IR/UV sevanja.
- Življenjska doba delovanja:
- 50.000 ur z izkoristkom > 80 % začetnega svetlobnega toka (L80B10).
- Prikluček za delovanje na 230V-50/60Hz.
- Na voljo z možnostjo zatemnitve.
- Na voljo kot stropna ali viseče svetilo.

NA ZAHTEVO

- Prikluček za sistem zasilne razsvetljave, za eno ali tri ure.
- Z mikroprizmatičnim pokrovom.
- Na voljo v različici gor/dol.

CYCLONE SLIM



- Aluminijasto ohišje, prašno barvano v izbrani barvi.
- CRI: min. 80 / SDCM: 3

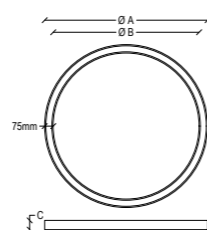

CYCLONE SLIM 1

KODA PRODUKTA: 8241052X_*
3000K 38W 3800lm 100lm/W ØA 600mm, ØB 450mm, C 80mm

KODA PRODUKTA: 8241053X_*
4000K 38W 3800lm 100lm/W ØA 600mm, ØB 450mm, C 80mm

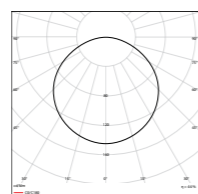

CYCLONE SLIM 2

KODA PRODUKTA: 8241062X_
3000K 52W 5200lm 100lm/W ØA 800mm, ØB 650mm, C 80mm

KODA PRODUKTA: 8241063X_
4000K 52W 5200lm 100lm/W ØA 800mm, ØB 650mm, C 80mm

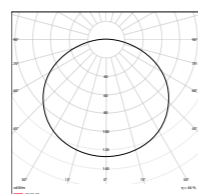

CYCLONE SLIM 3

KODA PRODUKTA: 8241072X_
3000K 79W 7900lm 100lm/W ØA 1100mm, ØB 950mm, C 80mm

KODA PRODUKTA: 8241073X_
4000K 79W 7900lm 100lm/W ØA 1100mm, ØB 950mm, C 80mm

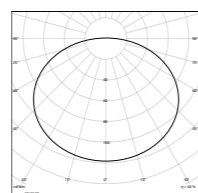

CYCLONE SLIM 4

KODA PRODUKTA: 8241082X_
3000K 99W 9900lm 100lm/W ØA 1450mm, ØB 1300mm, C 80mm

KODA PRODUKTA: 8241083X_
4000K 99W 9900lm 100lm/W ØA 1450mm, ØB 1300mm, C 80mm

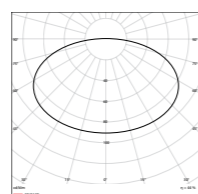

DOPOLNITEV KODE PRODUKTA:

X = BARVA

ostale barve = 0 titan = 2
bela = 1 črna = 3

_ = D (dimmer)

Za svetilo z možnostjo zatemnitve (dimmer) dodajte črko D na koncu kode produkta.

* Pri dimmer različici svetila CYCLONE SLIM 1 je napajalni modul nameščen izven telesa svetila.



CYCLONE SLIM



- Aluminijasto ohišje, prašno barvano v izbrani barvi.
- CRI: min. 80 / SDCM: 3

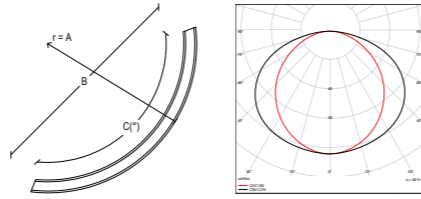

CYCLONE SLIM ROUND

KODA PRODUKTA: 8241662X_	3000K 25W 2500lm 100lm/W ØA 800mm, B 800mm, C 180°
KODA PRODUKTA: 8241663X_	4000K 25W 2500lm 100lm/W ØA 800mm, B 800mm, C 180°
KODA PRODUKTA: 8241672X_	3000K 38W 3800lm 100lm/W ØA 1100mm, B 1100mm, C 90°
KODA PRODUKTA: 8241673X_	4000K 38W 3800lm 100lm/W ØA 1100mm, B 1100mm, C 90°
KODA PRODUKTA: 8241682X_	3000K 22W 2200lm 100lm/W ØA 1450mm, B 1025mm, C 90°
KODA PRODUKTA: 8241683X_	4000K 22W 2200lm 100lm/W ØA 1450mm, B 1025mm, C 90°
KODA PRODUKTA: 8241692X_	3000K 48W 4800lm 100lm/W ØA 1450mm, B 1450mm, C 180°
KODA PRODUKTA: 8241693X_	4000K 48W 4800lm 100lm/W ØA 1450mm, B 1450mm, C 180°
KODA PRODUKTA: 8241702X_	3000K 18W 1800lm 100lm/W ØA 2000mm, B 765mm, C 45°
KODA PRODUKTA: 8241703X_	4000K 18W 1800lm 100lm/W ØA 2000mm, B 765mm, C 45°
KODA PRODUKTA: 8241712X_	3000K 35W 3500lm 100lm/W ØA 2000mm, B 1415mm, C 90°
KODA PRODUKTA: 8241713X_	4000K 35W 3500lm 100lm/W ØA 2000mm, B 1415mm, C 90°
KODA PRODUKTA: 8241722X_	3000K 48W 4800lm 100lm/W ØA 2000mm, B 1730mm, C 120°
KODA PRODUKTA: 8241723X_	4000K 48W 4800lm 100lm/W ØA 2000mm, B 1730mm, C 120°
KODA PRODUKTA: 8241732X_	3000K 22W 2200lm 100lm/W ØA 2500mm, B 955mm, C 45°
KODA PRODUKTA: 8241733X_	4000K 22W 2200lm 100lm/W ØA 2500mm, B 955mm, C 45°

KODA PRODUKTA: 8241742X_	3000K 45W 4500lm 100lm/W ØA 2500mm, B 1770mm, C 90°
KODA PRODUKTA: 8241743X_	4000K 45W 4500lm 100lm/W ØA 2500mm, B 1770mm, C 90°
KODA PRODUKTA: 8241752X_	3000K 28W 2800lm 100lm/W ØA 3000mm, B 1150mm, C 45°
KODA PRODUKTA: 8241753X_	4000K 28W 2800lm 100lm/W ØA 3000mm, B 1150mm, C 45°
KODA PRODUKTA: 8241762X_	3000K 42W 4200lm 100lm/W ØA 3000mm, B 1765mm, C 72°
KODA PRODUKTA: 8241763X_	4000K 42W 4200lm 100lm/W ØA 3000mm, B 1765mm, C 72°
KODA PRODUKTA: 8241772X_	3000K 32W 3200lm 100lm/W ØA 3500mm, B 1340mm, C 45°
KODA PRODUKTA: 8241773X_	4000K 32W 3200lm 100lm/W ØA 3500mm, B 1340mm, C 45°
KODA PRODUKTA: 8241782X_	3000K 42W 4200lm 100lm/W ØA 3500mm, B 1750mm, C 60°
KODA PRODUKTA: 8241783X_	4000K 42W 4200lm 100lm/W ØA 3500mm, B 1750mm, C 60°
KODA PRODUKTA: 8241792X_	3000K 42W 4200lm 100lm/W ØA 4000mm, B 1725mm, C 51°
KODA PRODUKTA: 8241793X_	4000K 42W 4200lm 100lm/W ØA 4000mm, B 1725mm, C 51°
KODA PRODUKTA: 8241802X_	3000K 45W 4500lm 100lm/W ØA 4500mm, B 1940mm, C 51°
KODA PRODUKTA: 8241803X_	4000K 45W 4500lm 100lm/W ØA 4500mm, B 1940mm, C 51°
KODA PRODUKTA: 8241812X_	3000K 52W 5200lm 100lm/W ØA 5000mm, B 2150mm, C 51°
KODA PRODUKTA: 8241813X_	4000K 52W 5200lm 100lm/W ØA 5000mm, B 2150mm, C 51°

DOPOLNITEV KODE PRODUKTA:

X = BARVA _ = D (dimmer)
 ostale barve = 0 titan = 2
 bela = 1 črna = 3
 Za svetilo z možnostjo zatemnitve (dimmer) dodajte črko D na koncu kode produkta.

CYCLONE SLIM



- Aluminijasto ohišje, prašno barvano v izbrani barvi.
- CRI: min. 80 / SDCM: 3
- Na zahtevo v izdaji GOR/DOL.

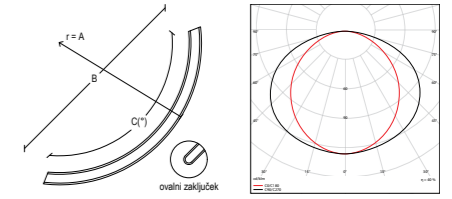
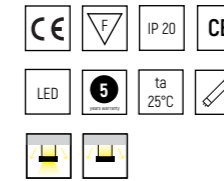

CYCLONE SLIM ROUND SMOOTH

KODA PRODUKTA: 8301362X_	3000K 50W 5000lm 100lm/W ØA 2000, B 1700mm, C 120°
KODA PRODUKTA: 8301363X_	4000K 50W 5000lm 100lm/W ØA 2000, B 1700mm, C 120°
KODA PRODUKTA: 8301372X_	3000K 43W 4300lm 100lm/W ØA 3000, B 1675mm, C 72°
KODA PRODUKTA: 8301373X_	4000K 43W 4300lm 100lm/W ØA 3000, B 1675mm, C 72°

KODA PRODUKTA: 8301382X_	3000K 43W 4300lm 100lm/W ØA 4000, B 1670mm, C 51°
KODA PRODUKTA: 8301383X_	4000K 43W 4300lm 100lm/W ØA 4000, B 1670mm, C 51°
KODA PRODUKTA: 8301392X_	3000K 53W 5300lm 100lm/W ØA 5000, B 2100mm, C 51°
KODA PRODUKTA: 8301393X_	4000K 53W 5300lm 100lm/W ØA 5000, B 2100mm, C 51°

DOPOLNITEV KODE PRODUKTA:

X = BARVA _ = D (dimmer)
 ostale barve = 0 titan = 2
 bela = 1 črna = 3
 Za svetilo z možnostjo zatemnitve (dimmer) dodajte črko D na koncu kode produkta.

CYCLONE SLIM



- Aluminijasto ohišje, prašno barvano v izbrani barvi.
- CRI: min. 80 / SDCM: 3

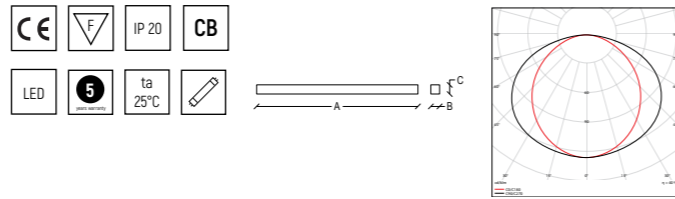

CYCLONE SLIM STRAIGHT

KODA PRODUKTA: 8241612X_
3000K 29W 2900lm 100lm/W A 1200mm, B 75mm, C 80mm

KODA PRODUKTA: 8241613X_
4000K 29W 2900lm 100lm/W A 1200mm, B 75mm, C 80mm

KODA PRODUKTA: 8241622X_
3000K 35W 3500lm 100lm/W A 1500mm, B 75mm, C 80mm

KODA PRODUKTA: 8241623X_
4000K 35W 3500lm 100lm/W A 1500mm, B 75mm, C 80mm

KODA PRODUKTA: 8241632X_
3000K 42W 4200lm 100lm/W A 1800mm, B 75mm, C 80mm

KODA PRODUKTA: 8241633X_
4000K 42W 4200lm 100lm/W A 1800mm, B 75mm, C 80mm

KODA PRODUKTA: 8241642X_
3000K 48W 4800lm 100lm/W A 2100mm, B 75mm, C 80mm

KODA PRODUKTA: 8241643X_
4000K 48W 4800lm 100lm/W A 2100mm, B 75mm, C 80mm

KODA PRODUKTA: 8241652X_
3000K 62W 6200lm 100lm/W A 2700mm, B 75mm, C 80mm

KODA PRODUKTA: 8241653X_
4000K 62W 6200lm 100lm/W A 2700mm, B 75mm, C 80mm



- Aluminijasto ohišje, prašno barvano v izbrani barvi.
- CRI: min. 80 / SDCM: 3
- Na zahtevo v izdaji GOR/DOL.

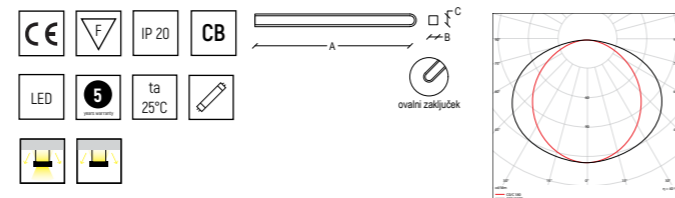

CYCLONE SLIM STRAIGHT SMOOTH

KODA PRODUKTA: 8301402X_
3000K 29W 2900lm 100lm/W ØA 1200mm, B 75mm, C 80mm

KODA PRODUKTA: 8301403X_
4000K 29W 2900lm 100lm/W ØA 1200mm, B 75mm, C 80mm

KODA PRODUKTA: 8301412X_
3000K 16W 1600lm 100lm/W ØA 600mm, B 75mm, C 80mm

KODA PRODUKTA: 8301413X_
4000K 16W 1600lm 100lm/W ØA 600mm, B 75mm, C 80mm

KODA PRODUKTA: 8301422X_
3000K 8W 800lm 100lm/W ØA 300mm, B 75mm, C 80mm

KODA PRODUKTA: 8301423X_
4000K 8W 800lm 100lm/W ØA 300mm, B 75mm, C 80mm

DOPOLNITEV KODE PRODUKTA:

X = BARVA

ostale barve = 0 titan = 2
bela = 1 črna = 3

_ = D (dimmer)

Za svetilo z možnostjo zatemnitve (dimmer) dodajte črko D na koncu kode produkta.

CYCLONE SLIM

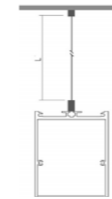

- Kabel in regulatorji iz nerjavečega jekla.
- Zahtevano: 3 kosi za vsak CYCLONE/CYCLONE SLIM 4 kosi za svetilko CYCLONE SLIM SMOOTH



NASTAVLJIVO OBEŠALO

KODA PRODUKTA: 900111
L 500mm 0,050kg

KODA PRODUKTA: 900112
L 1000mm 0,100kg

KODA PRODUKTA: 900113
L 1500mm 0,150kg

KODA PRODUKTA: 900114
L 2000mm 0,200kg

KODA PRODUKTA: 900116
L 3000mm 0,300kg



- Plastično ohišje s prozornim kablom.
- Z rozeto.



PLATFORMA

KODA PRODUKTA: 900122X
3x0,75mm² L 1000mm Ø75 0,120kg

KODA PRODUKTA: 900124X
3x0,75mm² L 2000mm Ø75 0,240kg

KODA PRODUKTA: 900126X
3x0,75mm² L 3000mm Ø75 0,360kg

KODA PRODUKTA: 900127X
3x0,75mm² L 4000mm Ø75 0,500kg

KODA PRODUKTA: 900162X
5x0,50mm² L 1000mm Ø75 0,120kg

KODA PRODUKTA: 900164X
5x0,50mm² L 2000mm Ø75 0,240kg

KODA PRODUKTA: 900166X
5x0,50mm² L 3000mm Ø75 0,360kg

KODA PRODUKTA: 900167X
5x0,50mm² L 4000mm Ø75 0,500kg



- Za viseča svetila.
- Ohišje iz aluminijastega profila s prozornim kablom.



PLATFORMA

KODA PRODUKTA: 90042X
3x0,75mm² L 200mm Ø80 0,130kg

KODA PRODUKTA: 90043X
3x0,75mm² L 2000mm Ø70 0,130kg

KODA PRODUKTA: 90048X
5x0,50mm² L 2000mm Ø100 0,250kg



- Za viseča svetila.
- Ohišje iz aluminijastega profila s prozornim kablom.



PLATFORMA

KODA PRODUKTA: 90044X
3x0,75mm² L 2000mm 80x80 0,210kg

KODA PRODUKTA: 90045X
3x0,75mm² L 2000mm 70x70 0,200kg

KODA PRODUKTA: 90049X
5x0,50mm² L 2000mm 100x100 0,300kg

DOPOLNITEV KODE PRODUKTA:

X = BARVA

ostale barve = 0 titan = 2
bela = 1 črna = 3

_ = D (dimmer)

Za svetilo z možnostjo zatemnitve (dimmer) dodajte črko D na koncu kode produkta.

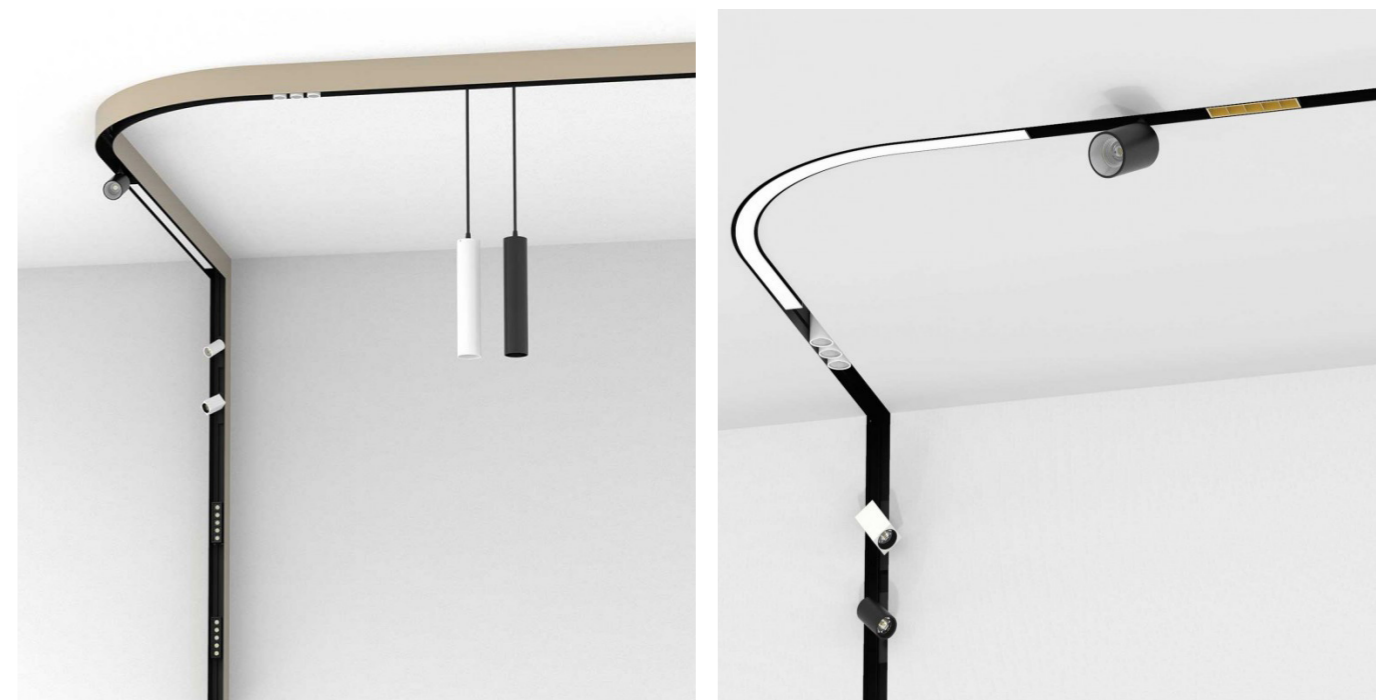

STORM je aluminijast profil za tračni sistem luči s tehnologijo pametnih magnetov. Je idealna rešitev za prostore, kjer so potrebna prilagajanja in spremembe svetil. V tem primeru je pri tračnem sistemu potrebno zamenjati le vstavljeno svetilo, npr. viseče svetilo zamenjamo z linijskim stropnim. Prednost tračnega sistema je tudi v tem, da je potreben dovod elektrike le iz ene točke.

TEHNIČNI PODATKI IN LASTNOSTI (tračnica)

- Aluminijasto ohišje, prašno barvano v izbrani barvi.
- Z nizkonapetostnim 24V DC tirom.
- Priključek za delovanje na 230V-50/60Hz.

TEHNIČNI PODATKI IN LASTNOSTI (svetila na tračnicah)

- Z nizkonapetostnim 24V DC magnetnim adapterjem za montažo na LV tiru max. 15A.
- Čista svetloba brez IR/UV sevanja.
- Učinkovito toplotno upravljanje.
- Življenjska doba delovanja: 50.000 ur z izkoristkom > 80 % začetnega svetlobnega toka (L80B10).

NA ZAHTEVO

- Na voljo tudi v 2700 K, CRI 90.

KARAKTERISTIKE



NAČIN PRITRDNITVE SVETILA



NAČIN OSVETLITVE



BARVE

- bela
- titan
- črna
- ostale barve

STORM SURFACE

- Prašno barvan aluminijast profil v izbrani barvi.
- Z niskonapetostnim 24V DC napajalnim modulom.
- Notranji del v črni barvi.



POZOR
Standardni dostavljeni izdelek je priključen na vezje 1 (V+/V-).
Za vezje 2 (D+/D-), je to potrebno definirati.

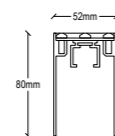

STORM SURFACE PROFIL

KODA PRODUKTA: 99711X
L 0,5m

KODA PRODUKTA: 99713X
L 2m

KODA PRODUKTA: 99712X
L 1m

KODA PRODUKTA: 99714X
L 3m

- Prašno barvan aluminijast profil v izbrani barvi.
- Z niskonapetostnim 24V DC napajalnim modulom.
- Notranji del v črni barvi.

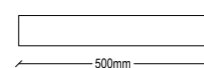

STORM SURFACE OHIŠJE Z NAPAJALNIKOM

KODA PRODUKTA: 99741X
60W L 0,5m

KODA PRODUKTA: 99744X
60W DALI L 0,5m

KODA PRODUKTA: 99742X
100W L 0,5m

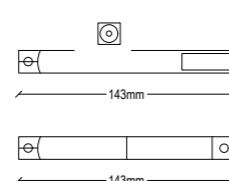

ZAKLJUČNI KONEKTOR

KODA PRODUKTA: 803611
bela

KODA PRODUKTA: 803621
bela

KODA PRODUKTA: 803613
črna

KODA PRODUKTA: 9803623
črna

DOPOLNITEV KODE PRODUKTA:

X = BARVA

- ostale barve = 0
- titan = 2
- bela = 1
- črna = 3

STORM SURFACE

- Zaključni pokrov iz aluminija v izbrani barvi.



- Konektor iz aluminija.



STORM SURFACE ZAKLJUČNI POKROV

KODA PRODUKTA: 99700X

STORM SURFACE KONEKTOR

KODA PRODUKTA: 997011

- Prašno barvan aluminijast profil v izbrani barvi.
- Notranji del v črni barvi.



- Prašno barvan aluminijast profil v izbrani barvi.
- Notranji del v črni barvi.



STORM SURFACE ANGLE BEND

KODA PRODUKTA: 99718X

STORM SURFACE ANGLE BEND 2

KODA PRODUKTA: 99719X

*To create lighting angle in combination with STRIPE ANGLE BEND STR

- Prašno barvan aluminijast profil v izbrani barvi.
- Notranji del v črni barvi.



- Prašno barvan aluminijast profil v izbrani barvi.
- Notranji del v črni barvi.

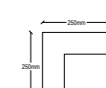

STORM SURFACE ANGLE

KODA PRODUKTA: 99717X

STORM SURFACE ANGLE WALL

KODA PRODUKTA: 99716X

DOPOLNITEV KODE PRODUKTA:

X = BARVA

- ostale barve = 0
- titan = 2
- bela = 1
- črna = 3

STORM SURFACE



STORM SURFACE OBEŠALO

KODA PRODUKTA: 997021
L 500mm

KODA PRODUKTA: 997022
L 1000mm



- Za viseča svetila.
- Ohišje iz aluminijastega profila s prozornim kablom.



PLATFORMA

KODA PRODUKTA: 90042X
3x0,75mm² L 2000mm Ø80 0,130kg

KODA PRODUKTA: 90043X
3x0,75mm² L 2000mm Ø70 0,130kg

KODA PRODUKTA: 90048X
5x0,50mm² L 2000mm Ø100 0,250kg

KODA PRODUKTA: 997023
L 2000mm

KODA PRODUKTA: 997024
L 3000mm



- Za viseča svetila.
- Ohišje iz aluminijastega profila s prozornim kablom.



PLATFORMA

KODA PRODUKTA: 90044X
3x0,75mm² L 2000mm 80x80 0,210kg

KODA PRODUKTA: 90045X
3x0,75mm² L 2000mm 70x70 0,200kg

KODA PRODUKTA: 90049X
5x0,50mm² L 2000mm 100x100 0,300kg

STORM SURFACE

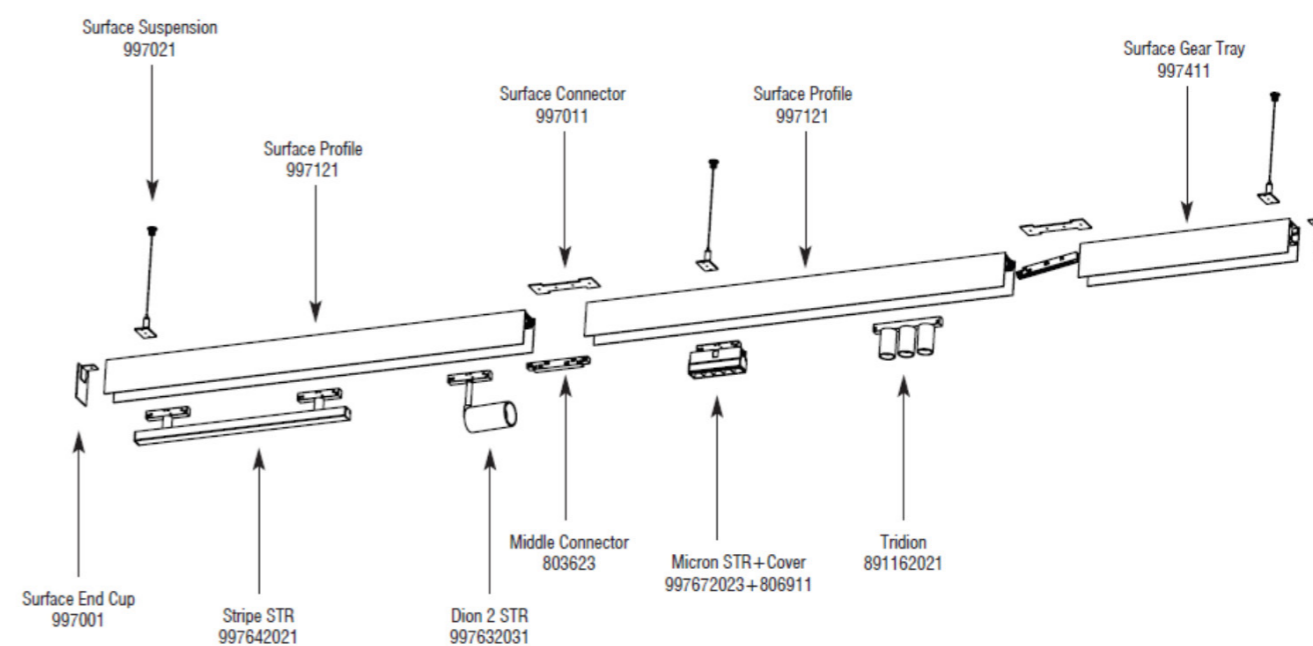

DOPOLNITEV KODE PRODUKTA:

X = BARVA

ostale barve = 0 titan = 2
bela = 1 črna = 3

STORM TRIMLESS

- Aluminijasti profil.
- Z niskonapetostnim 24V DC tirom.
- Notranji del v črni barvi.



POZOR
Standardni dostavljeni izdelek je priključen na vezje 1 (V+/V-).
Za vezje 2 (D+/D-), je to potrebno definirati.

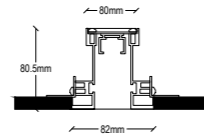

STORM TRIMLESS PROFIL

KODA PRODUKTA: 997213
L 500mm

KODA PRODUKTA: 997223
L 1000mm

KODA PRODUKTA: 997233
L 2000mm

KODA PRODUKTA: 997243
L 3000mm

- Aluminijasti profil.
- Z niskonapetostnim 24V DC napajalnim modulom.
- Notranji del v črni barvi.

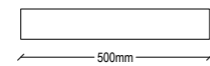

STORM SURFACE OHIŠJE Z NAPAVALNIKOM

KODA PRODUKTA: 997513
60W L 500mm

KODA PRODUKTA: 997523
100W L 500mm

KODA PRODUKTA: 997543
60W DALI L 500mm

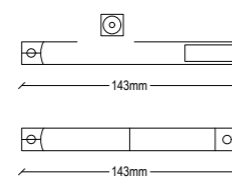

ZAKLJUČNI KONEKTOR

KODA PRODUKTA: 803611
bela

KODA PRODUKTA: 803613
črna

NAPAVALNI KONEKTOR

KODA PRODUKTA: 803621
bela

KODA PRODUKTA: 9803623
črna

STORM TRIMLESS

- Iz aluminija.



STORM TRIMLESS ZAKLJUČNI POKROV

KODA PRODUKTA: 997053

- Iz aluminija.
- Količina: v paru.



STORM TRIMLESS POVEZOVALNI KONEKTOR

KODA PRODUKTA: 968255

- Iz aluminija.
- Zahtevano:
Dva kosa za 0,5m TRIMLESS profil.



STORM TRIMLESS NOSILEC OHIŠJA

KODA PRODUKTA: 997061

- Aluminijasti profil.
- Notranji del v črni barvi.

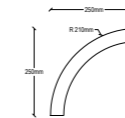

STORM TRIMLESS ANGLE BEND

KODA PRODUKTA: 99717X

- Aluminijasti profil.
- Notranji del v črni barvi.

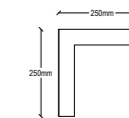

STORM TRIMLESS ANGLE

KODA PRODUKTA: 99716X

STORM TRIMLESS

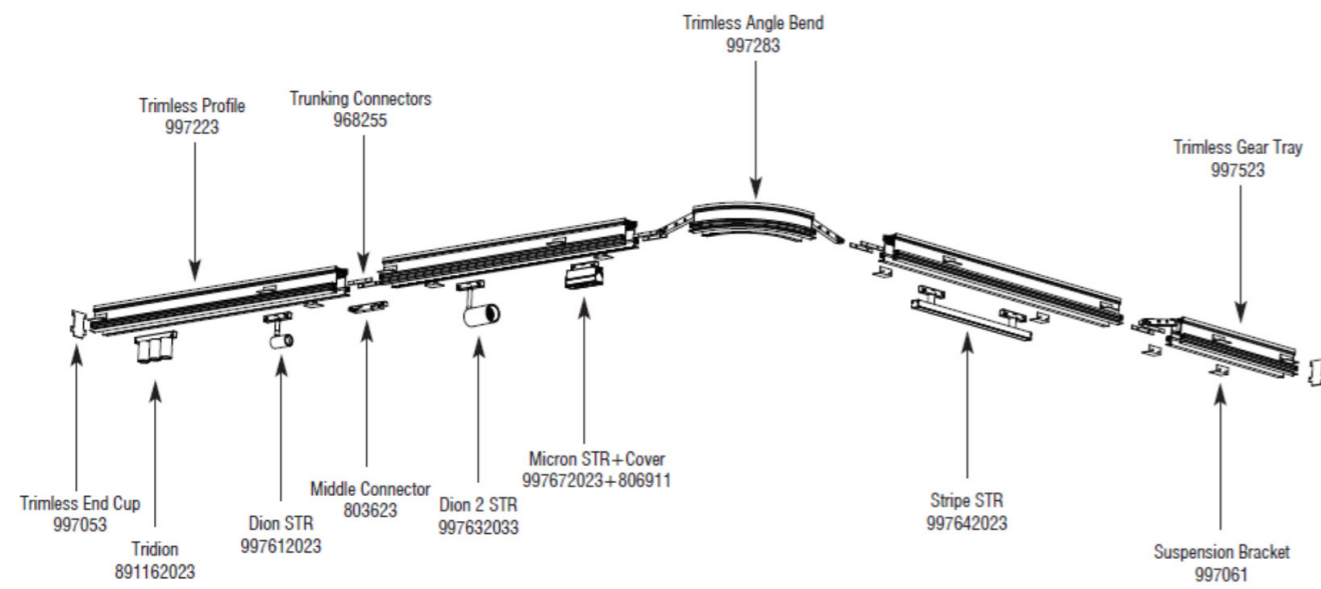



- Aluminijasto ohišje.
- Leča s snopom svetlobe v točkovni, srednji in široki različici.
- Z nizkonapetostnim 24V DC magnetnim adapterjem.
- CRI: min. 90 / SDCM: 3

POZOR
Standardni dostavljeni izdelek je priključen na vezje 1 (V+/V-).
Za vezje 2 (D+/D-), je to potrebno definirati.

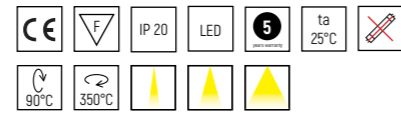

DION STR TRACK

KODA PRODUKTA: 997612ZX
LED 3000K 6W 600lm 100lm/W 0,150kg

KODA PRODUKTA: 997613ZX
LED 4000K 6W 600lm 100lm/W 0,150kg

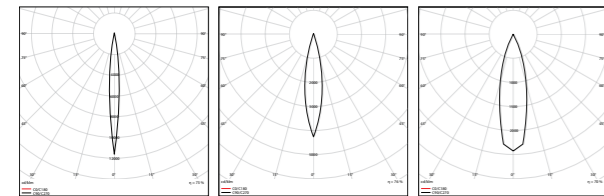

ozek žarek srednje širok žarek širok žarek



- Aluminijasto ohišje.
- Leča s snopom svetlobe v točkovni, srednji in široki različici.
- Z nizkonapetostnim 24V DC magnetnim adapterjem.
- CRI: min. 90 / SDCM: 3

POZOR
Standardni dostavljeni izdelek je priključen na vezje 1 (V+/V-).
Za vezje 2 (D+/D-), je to potrebno definirati.

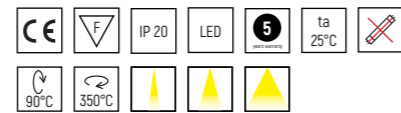

DION Q STR TRACK

KODA PRODUKTA: 997622ZX
LED 3000K 6W 600lm 100lm/W 0,200kg

KODA PRODUKTA: 997623ZX
LED 4000K 6W 600lm 100lm/W 0,200kg

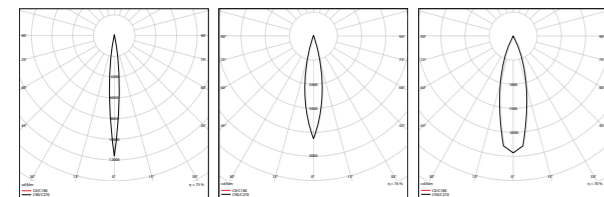

ozek žarek srednje širok žarek širok žarek

DOPOLNITEV KODE PRODUKTA:

X = BARVA

- ostale barve = 0
- bela = 1

- titan = 2
- črna = 3

Z = ŽAREK

- ozek žarek = 01
- srednje širok žarek = 02
- širok žarek = 03



- Aluminijasto ohišje.
- Leča s snopom svetlobe v srednji in široki različici.
- Z nizkonapetostnim 24V DC magnetnim adapterjem.
- CRI: min. 90 / SDCM: 3

POZOR
Standardni dostavljeni izdelek je priključen na vezje 1 (V+/V-).
Za vezje 2 (D+/D-), je to potrebno definirati.

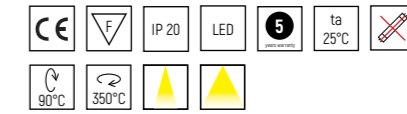

DION 2 STR TRACK

KODA PRODUKTA: 997632ZX
LED 3000K 9W 900lm 100lm/W 0,250kg

KODA PRODUKTA: 997633ZX
LED 4000K 9W 900lm 100lm/W 0,250kg

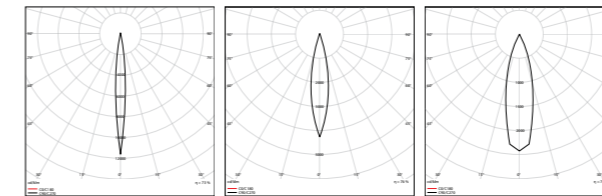

ozek žarek srednje širok žarek širok žarek



- Aluminijasto ohišje.
- Z nizkonapetostnim 24V DC magnetnim adapterjem.
- CRI: min. 90 / SDCM: 3

POZOR
Standardni dostavljeni izdelek je priključen na vezje 1 (V+/V-).
Za vezje 2 (D+/D-), je to potrebno definirati.

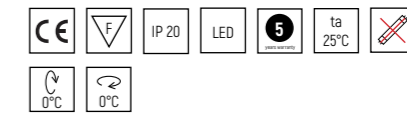

STRIPE STR TRACK

KODA PRODUKTA: 99764201X
LED 3000K 3W 300lm 100lm/W L 300mm 0,300kg

KODA PRODUKTA: 99764301X
LED 4000K 3W 300lm 100lm/W L 300mm 0,300kg

KODA PRODUKTA: 99764202X
LED 3000K 5W 500lm 100lm/W L 500mm 0,400kg

KODA PRODUKTA: 99764302X
LED 4000K 5W 500lm 100lm/W L 500mm 0,400kg

KODA PRODUKTA: 99764203X
LED 3000K 10W 1000lm 100lm/W L 1000mm 0,800kg

KODA PRODUKTA: 99764303X
LED 4000K 10W 1000lm 100lm/W L 1000mm 0,800kg

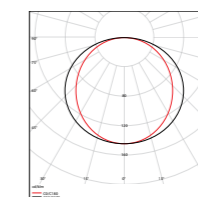
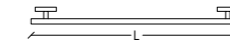

DOPOLNITEV KODE PRODUKTA:

X = BARVA

- ostale barve = 0
- bela = 1

- titan = 2
- črna = 3

Z = ŽAREK

- ozek žarek = 01
- srednje širok žarek = 02
- širok žarek = 03



- Aluminijasto ohišje.
- Z nizkonapetostnim 24V DC magnetnim adapterjem.
- CRI: min. 90 / SDCM: 3
- V kombinaciji samo z STORM Surface ANGLE BEND 2.

POZOR
Standardni dostavljeni izdelek je priključen na vezje 1 (V+/V-).
Za vezje 2 (D+/D-), je to potrebno definirati.

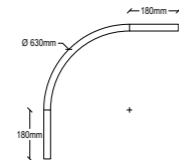
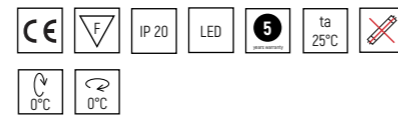

STRIPE ANGLE BEND STR TRACK

KODA PRODUKTA: 99765201X
LED 3000K 5W 500lm 100lm/W

KODA PRODUKTA: 99765301X
LED 4000K 5W 500lm 100lm/W



- Aluminijasto ohišje.
- Leča s snopom svetlobe v točkovni, srednji in široki različici.
- Z nizkonapetostnim 24V DC magnetnim adapterjem.
- CRI: min. 90 / SDCM: 3

POZOR
Standardni dostavljeni izdelek je priključen na vezje 1 (V+/V-).
Za vezje 2 (D+/D-), je to potrebno definirati.

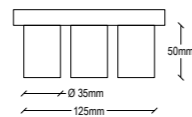
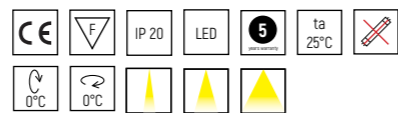

TRIDION

KODA PRODUKTA: 891162ZX
LED 3000K 3x6W 600lm 100lm/W 0,350kg

KODA PRODUKTA: 891163ZX
LED 4000K 3x6W 600lm 100lm/W 0,350kg

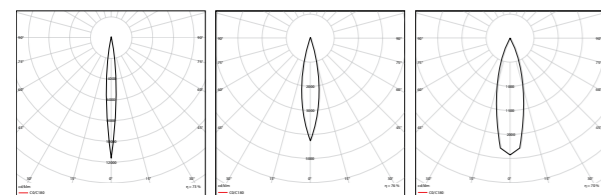

ozek žarek srednje širok žarek širok žarek

DOPOLNITEV KODE PRODUKTA:

- X = BARVA Z = ŽAREK
- ostale barve = 0 titan = 2 ozek žarek = 01 širok žarek = 03
 - bela = 1 črna = 3 srednje širok žarek = 02



- Aluminijasto ohišje, prašno barvano v črni barvi.
- Z nizkonapetostnim 24V DC magnetnim adapterjem.
- Plastični pokrov ni priložen, na voljo ločeno.
- 5x2W poraba energije.
- CRI: min. 90 / SDCM: 3

POZOR
Standardni dostavljeni izdelek je priključen na vezje 1 (V+/V-).
Za vezje 2 (D+/D-), je to potrebno definirati.

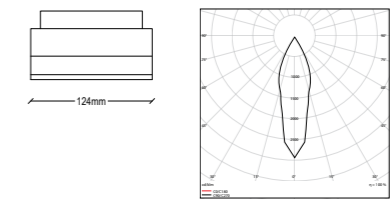
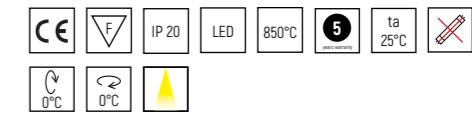

MICRON STR

KODA PRODUKTA: 997672023
LED 3000K 5x2W 200lm 100lm/W 0,480kg

KODA PRODUKTA: 997673023
LED 3000K 5x2W 200lm 100lm/W 0,480kg



- Plastični pokrov za 5x. Micron.



MICRON COVER

KODA PRODUKTA: 806910
črna

KODA PRODUKTA: 806911
zlata

KODA PRODUKTA: 806912
srebrna



- Aluminijasto ohišje.
- Leča s snopom svetlobe v srednji in široki različici.
- Z nizkonapetostnim 24V DC magnetnim adapterjem.
- CRI: min. 90 / SDCM: 3

POZOR
Standardni dostavljeni izdelek je priključen na vezje 1 (V+/V-).
Za vezje 2 (D+/D-), je to potrebno definirati.

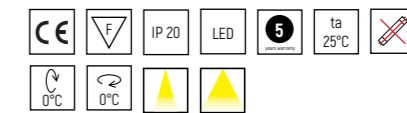

DION 2 PENDANT

KODA PRODUKTA: 89117202X
LED 3000K 9W 900lm 100lm/W 24° 0,300kg

KODA PRODUKTA: 89117302X
LED 4000K 9W 900lm 100lm/W 24° 0,300kg

KODA PRODUKTA: 89117203X
LED 3000K 9W 900lm 100lm/W 32° 0,300kg

KODA PRODUKTA: 89117303X
LED 4000K 9W 900lm 100lm/W 32° 0,300kg

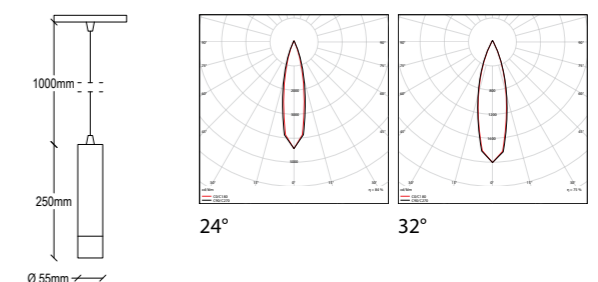

DOPOLNITEV KODE PRODUKTA:

- X = BARVA
- ostale barve = 0 titan = 2
 - bela = 1 črna = 3

STORM

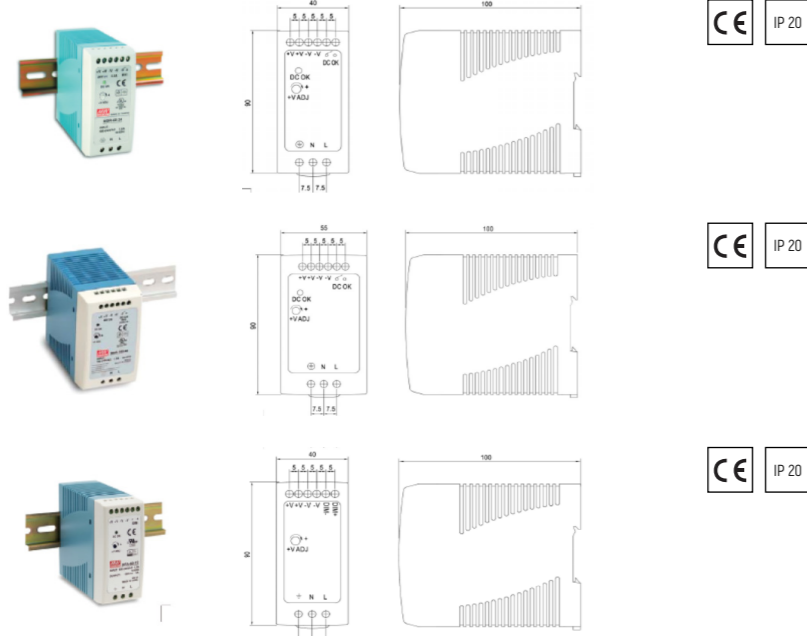

UNIVERZALNI DIN RAIL 35mm LED NAPAJALNIK 24V DC

KODA PRODUKTA: 800103
60W

KODA PRODUKTA: 800104
100W

KODA PRODUKTA: 800107
60W dimmer*

* PWM / 1-10V DC

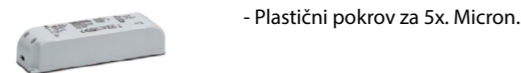

- Plastični pokrov za 5x. Micron.



LED NAPAJALNIK 24V DC

KODA PRODUKTA: 800071
30W

KODA PRODUKTA: 800105
60W

KODA PRODUKTA: 800106
100W

* Dali in gumb
** Fazni izrez / 1-10V DC

KODA PRODUKTA: 800018
24V DC 60W dimmer*

KODA PRODUKTA: 800017
24V DC 100W dimmer*

KODA PRODUKTA: 800101
24V DC 60W dimmer**

KODA PRODUKTA: 800102
24V DC 100W dimmer**

DOPOLNITEV KODE PRODUKTA:

X = BARVA

ostale barve = 0
bela = 1

titan = 2
črna = 3

Z = ŽAREK

ozek žarek = 01
srednje širok žarek = 02

širok žarek = 03



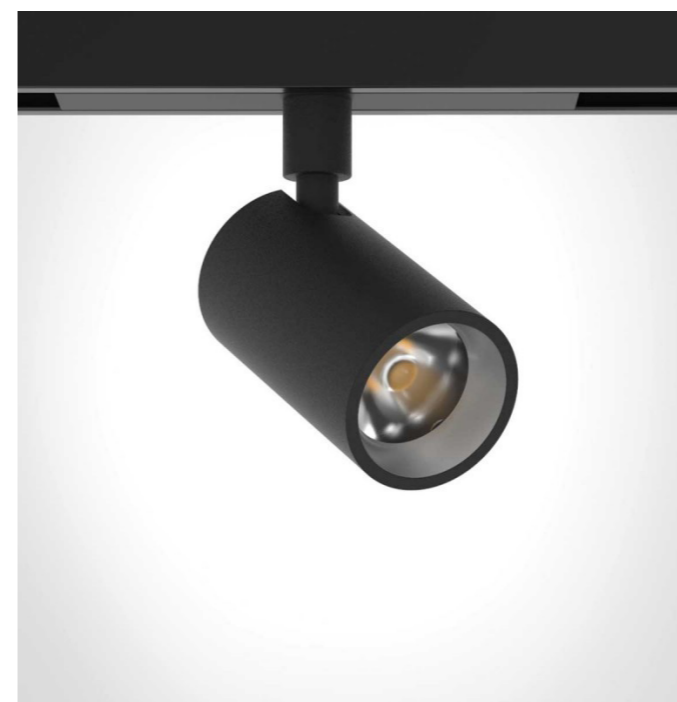

DION je tračna svetilka s tehnologijo pametnega magneta. Je idealna rešitev za osvetljevanje predmetov ali površin, ki potrebujejo usmerjeno svetlobo, kot so galerije, muzeji, razstave, ipd.

TEHNIČNI PODATKI IN LASTNOSTI

- Aluminijasto ohišje, prašno barvano v izbrani barvi.
- Z nizkonapetostnim 24V DC magnetnim adapterjem za montažo na LV tiru max. 15A.
- S točkovnim izhodom za nadgradno montažo v krogu, kvadratu ali v liniji.
- Čista svetloba brez IR/UV sevanja.
- Učinkovito toplotno upravljanje.
- Življenjska doba delovanja: 50.000 ur z izkoristkom > 80 % začetnega svetlobnega toka (L80B10).
- Priključek za delovanje na 24V DC.
- Na voljo z možnostjo zatemnitve.
- Na voljo v točkovni, srednji in široki porazdelitvi svetlobe.

NA ZAHTEVO

- Na voljo tudi v 2700 K, CRI 90.

KARAKTERISTIKE



NAČIN PRITRDNITVE SVETILA



NAČIN OSVELTITVE



BARVE

- bela
- titan
- črna
- ostale barve



- Aluminijasto ohišje.
- Leča s snopom svetlobe v točkovni, srednji in široki različici.
- Z nizkonapetostnim 24V DC magnetnim adapterjem.
- CRI: min. 90 / SDCM: 3

POZOR
Standardni dostavljeni izdelek je priključen na vezje 1 (V+/V-). Za vezje 2 (D+/D-), je to potrebno definirati.

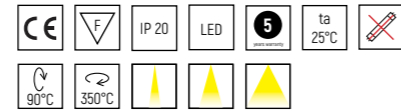

DION SURFACE

KODA PRODUKTA: 89110201X
LED 3000K 6W 600lm 100lm/W ozek žarek 0,150kg

KODA PRODUKTA: 89110202X
LED 3000K 6W 600lm 100lm/W sr. širok žarek 0,150kg

KODA PRODUKTA: 89110203X
LED 3000K 6W 600lm 100lm/W širok žarek 0,150kg

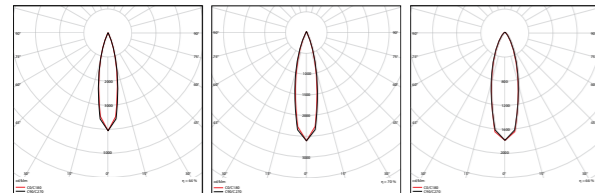

ozek žarek srednje širok žarek širok žarek



- Aluminijasto ohišje.
- Leča s snopom svetlobe v točkovni, srednji in široki različici.
- Z nizkonapetostnim 24V DC magnetnim adapterjem.
- CRI: min. 90 / SDCM: 3

POZOR
Standardni dostavljeni izdelek je priključen na vezje 1 (V+/V-). Za vezje 2 (D+/D-), je to potrebno definirati.

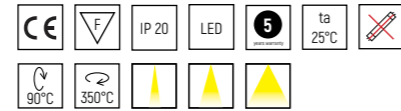

DION L

KODA PRODUKTA: 89112201X
LED 3000K 6W 600lm 100lm/W ozek žarek 0,200kg

KODA PRODUKTA: 89112202X
LED 3000K 6W 600lm 100lm/W sr. širok žarek 0,200kg

KODA PRODUKTA: 89112203X
LED 3000K 6W 600lm 100lm/W širok žarek 0,200kg

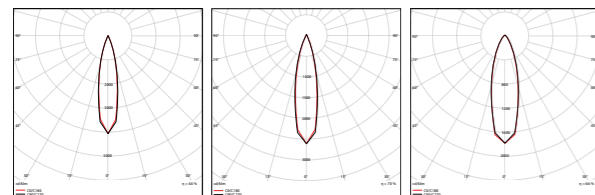

ozek žarek srednje širok žarek širok žarek

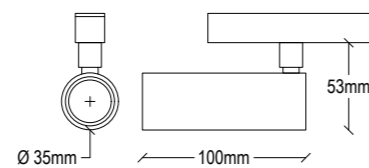

DOPOLNITEV KODE PRODUKTA:

X = BARVA

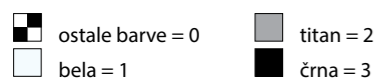

- Aluminijasto ohišje.
- Leča s snopom svetlobe v srednji in široki različici.
- Z nizkonapetostnim 24V DC magnetnim adapterjem.
- CRI: min. 90 / SDCM: 3

POZOR
Standardni dostavljeni izdelek je priključen na vezje 1 (V+/V-). Za vezje 2 (D+/D-), je to potrebno definirati.

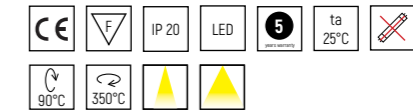

DION Q

KODA PRODUKTA: 89111201X
LED 3000K 6W 600lm 100lm/W ozek žarek 0,200kg

KODA PRODUKTA: 89111202X
LED 3000K 6W 600lm 100lm/W sr. širok žarek 0,200kg

KODA PRODUKTA: 89111203X
LED 3000K 6W 600lm 100lm/W širok žarek 0,200kg

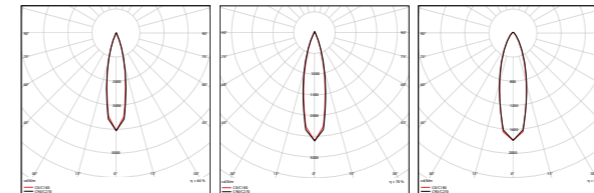

ozek žarek srednje širok žarek širok žarek

KODA PRODUKTA: 89111301X
LED 4000K 6W 600lm 100lm/W ozek žarek 0,200kg

KODA PRODUKTA: 89111302X
LED 4000K 6W 600lm 100lm/W sr. širok žarek 0,200kg

KODA PRODUKTA: 89111303X
LED 4000K 6W 600lm 100lm/W širok žarek 0,200kg

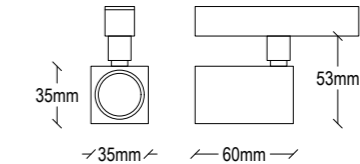

- Aluminijasto ohišje.
- Leča s snopom svetlobe v srednji in široki različici.
- Z nizkonapetostnim 24V DC magnetnim adapterjem.
- CRI: min. 90 / SDCM: 3

POZOR
Standardni dostavljeni izdelek je priključen na vezje 1 (V+/V-). Za vezje 2 (D+/D-), je to potrebno definirati.

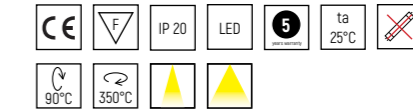

DION 2

KODA PRODUKTA: 89114202X
LED 3000K 9W 900lm 100lm/W sr. širok žarek 0,250kg

KODA PRODUKTA: 89114203X
LED 3000K 9W 900lm 100lm/W širok žarek 0,250kg

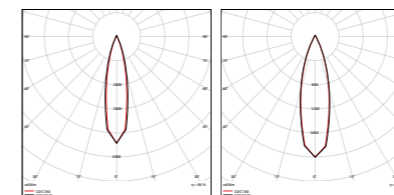

srednje širok žarek širok žarek

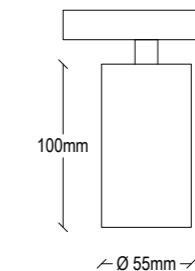

DOPOLNITEV KODE PRODUKTA:

X = BARVA

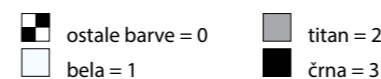



- Aluminijasto ohišje.
- Leča s snopom svetlobe v točkovni, srednji in široki različici.
- Z nizkonapetostnim 24V DC magnetnim adapterjem.
- CRI: min. 90 / SDCM: 3

POZOR
Standardni dostavljeni izdelek je priključen na vezje 1 (V+/V-).
Za vezje 2 (D+/D-), je to potrebno definirati.

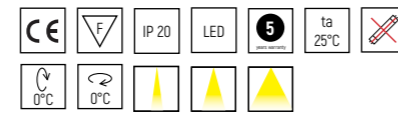

TRIDION

KODA PRODUKTA: 89116201X
LED 3000K 3x6W 600lm 100lm/W ozek žarek 0,350kg

KODA PRODUKTA: 89116202X
LED 3000K 3x6W 600lm 100lm/W sr. širok žarek 0,350kg

KODA PRODUKTA: 89116203X
LED 3000K 3x6W 600lm 100lm/W širok žarek 0,350kg

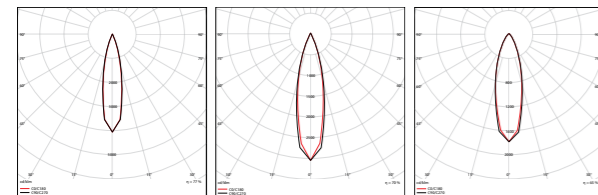

ozek žarek srednje širok žarek širok žarek

KODA PRODUKTA: 89116301X
LED 4000K 3x6W 600lm 100lm/W ozek žarek 0,350kg

KODA PRODUKTA: 89116302X
LED 4000K 3x6W 600lm 100lm/W sr. širok žarek 0,350kg

KODA PRODUKTA: 89116303X
LED 4000K 3x6W 600lm 100lm/W širok žarek 0,350kg

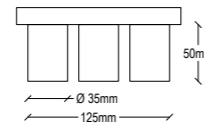

- Aluminijasto ohišje.
- Leča s snopom svetlobe v srednji in široki različici.
- Z nizkonapetostnim 24V DC magnetnim adapterjem.
- CRI: min. 90 / SDCM: 3

POZOR
Standardni dostavljeni izdelek je priključen na vezje 1 (V+/V-).
Za vezje 2 (D+/D-), je to potrebno definirati.

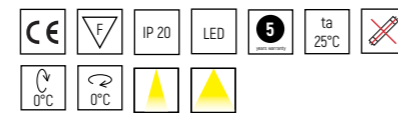

DION 2 PENDANT

KODA PRODUKTA: 89117202X
LED 3000K 9W 900lm 100lm/W 24° 0,300kg

KODA PRODUKTA: 89117203X
LED 3000K 9W 900lm 100lm/W 32° 0,300kg

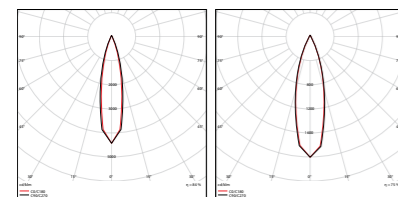

24° 32°

KODA PRODUKTA: 89117302X
LED 4000K 9W 900lm 100lm/W 24° 0,300kg

KODA PRODUKTA: 89117303X
LED 4000K 9W 900lm 100lm/W 32° 0,300kg

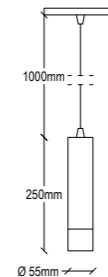

DOPOLNITEV KODE PRODUKTA:

X = BARVA

- ostale barve = 0
- titan = 2
- bela = 1
- črna = 3



- Za vgradno namestitev.
- Aluminijasto ohišje.
- Objektiv s snopom svetlobe v točkovni, srednji in široki različici.
- CRI: min. 80 / SDCM: 3

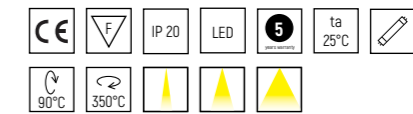

DION RECESSED

KODA PRODUKTA: 89070201X
3000K 4W 400lm 100lm/W ozek žarek 0,300kg

KODA PRODUKTA: 89070202X
3000K 4W 400lm 100lm/W sr. širok žarek 0,300kg

KODA PRODUKTA: 89070203X
3000K 4W 400lm 100lm/W širok žarek 0,300kg

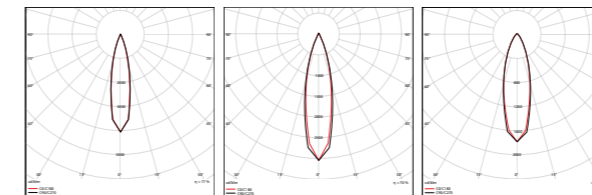

ozek žarek srednje širok žarek širok žarek

KODA PRODUKTA: 89070301X
4000K 4W 400lm 100lm/W ozek žarek 0,300kg

KODA PRODUKTA: 89070302X
4000K 4W 400lm 100lm/W sr. širok žarek 0,300kg

KODA PRODUKTA: 89070303X
4000K 4W 400lm 100lm/W širok žarek 0,300kg

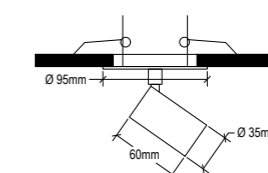

DOPOLNITEV KODE PRODUKTA:

X = BARVA

- ostale barve = 0
- titan = 2
- bela = 1
- črna = 3

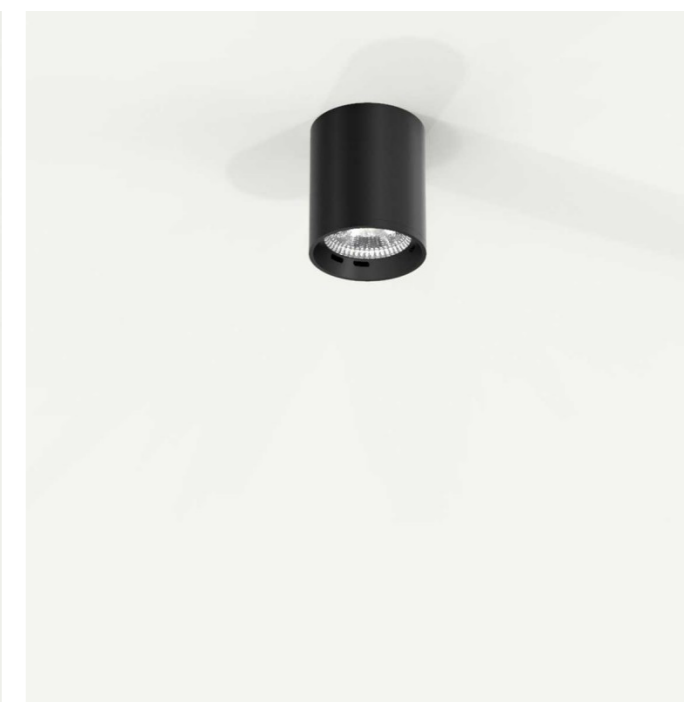

ROLLER je stropna nadgradna ali viseča svetilka cilindrične oblike, primerna za osvetljevanje hodnikov ter prostorov in površin manjših dimenzij.

TEHNIČNI PODATKI IN LASTNOSTI

- Aluminijasto ohišje.
- Visoko učinkoviti reflektorji na voljo v različicah z ozkim, srednje širokim in širokim snopom svetlobe.

TEHNIČNI PODATKI IN LASTNOSTI (za LED različico)

- Čista svetloba brez IR/UV sevanja.
- Učinkovito toplotno upravljanje.
- Življenjska doba delovanja: 50.000 ur z izkoristkom > 80% začetnega svetlobnega toka (L80B10).

NA ZAHTEVO

- Na voljo z višjim indeksom barvnega upodabljanja (CRI).

KARAKTERISTIKE



NAČIN PRITRDNITVE SVETILA



NAČIN OSVETLITVE



BARVE

- bela
- titan
- črna
- ostale barve

POVRŠINSKE OBDELAVE

- krom
- mat aluminij

ROLLER

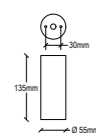
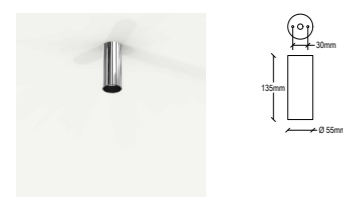

- Aluminijasto ohišje, prašno barvano v izbrani barvi (znotraj in zunaj enake barve pri standardni izvedbi) ali prevlečeno (notranji del v črni barvi).
- 8W poraba energije pri 350mA.
- CRI: min. 80 / SDCM: 3

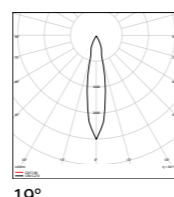
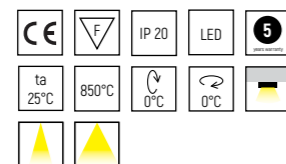
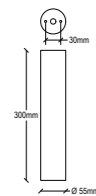

19°

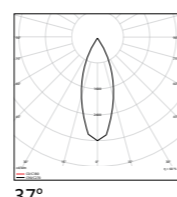

37°

ROLLER 6

KODA PRODUKTA: 88047202X	LED 3000K	8W	800lm	100 lm/W	19°	H 135mm	0,700kg
KODA PRODUKTA: 88047302X	LED 4000K	8W	800lm	100 lm/W	19°	H 135mm	0,700kg
KODA PRODUKTA: 88047203X	LED 3000K	8W	800lm	100 lm/W	37°	H 135mm	0,700kg
KODA PRODUKTA: 88047303X	LED 4000K	8W	800lm	100 lm/W	37°	H 135mm	0,700kg
KODA PRODUKTA: 88048202X	LED 3000K	8W	800lm	100 lm/W	19°	H 300mm	1,000kg
KODA PRODUKTA: 88048302X	LED 4000K	8W	800lm	100 lm/W	19°	H 300mm	1,000kg
KODA PRODUKTA: 88048203X	LED 3000K	8W	800lm	100 lm/W	37°	H 300mm	1,000kg
KODA PRODUKTA: 88048303X	LED 4000K	8W	800lm	100 lm/W	37°	H 300mm	1,000kg

DOPOLNITEV KODE PRODUKTA:

X = BARVA

	ostale barve = 0		titan = 2		krom = 4
	bela = 1		črna = 3		mat aluminij = 5

_ = D (dimmer)

Za svetilo z možnostjo zatemnitve (dimmer) dodajte črko D na koncu kode produkta.

ROLLER

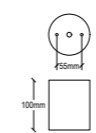
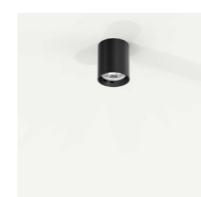

- Aluminijasto ohišje, prašno barvano v izbrani barvi ali prevlečeno.
- 230V/50Hz modul.
- Fazni izrez zatemnilnika.
- CRI: min. 80 / SDCM: 3

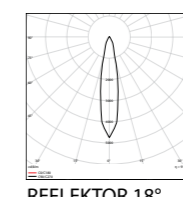
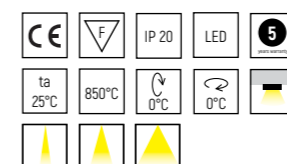
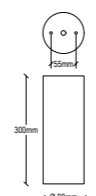

REFLEKTOR 18°

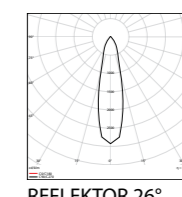

REFLEKTOR 26°

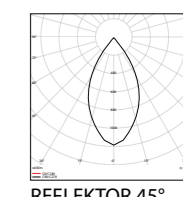

REFLEKTOR 45°

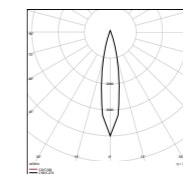

LEČA 19°

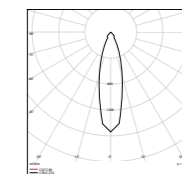

LEČA 27°

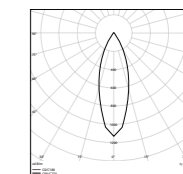

LEČA 33°

ROLLER 9 REFLEKTOR

KODA PRODUKTA: 88004201X	LED 3000K	10W	1000lm	100 lm/W	18°	H 100mm	0,900kg
KODA PRODUKTA: 88004301X	LED 4000K	10W	1000lm	100 lm/W	18°	H 100mm	0,900kg
KODA PRODUKTA: 88004202X	LED 3000K	10W	1000lm	100 lm/W	26°	H 100mm	0,900kg
KODA PRODUKTA: 88004302X	LED 4000K	10W	1000lm	100 lm/W	26°	H 100mm	0,900kg
KODA PRODUKTA: 88004203X	LED 3000K	10W	1000lm	100 lm/W	45°	H 100mm	0,900kg
KODA PRODUKTA: 88004303X	LED 4000K	10W	1000lm	100 lm/W	45°	H 100mm	0,900kg
KODA PRODUKTA: 88038201X	LED 3000K	20W	2000lm	100 lm/W	18°	H 300mm	1,500kg
KODA PRODUKTA: 88038301X	LED 4000K	20W	2100lm	106 lm/W	18°	H 300mm	1,500kg
KODA PRODUKTA: 88038202X	LED 3000K	20W	2000lm	100 lm/W	26°	H 300mm	1,500kg
KODA PRODUKTA: 88038302X	LED 4000K	20W	2000lm	103 lm/W	26°	H 300mm	1,500kg
KODA PRODUKTA: 88038203X	LED 3000K	20W	2000lm	100 lm/W	45°	H 300mm	1,500kg
KODA PRODUKTA: 88038303X	LED 4000K	20W	2050lm	104 lm/W	45°	H 300mm	1,500kg

DOPOLNITEV KODE PRODUKTA:

X = BARVA

	ostale barve = 0		titan = 2		krom = 4
	bela = 1		črna = 3		mat aluminij = 5

_ = D (dimmer)

Za svetilo z možnostjo zatemnitve (dimmer) dodajte črko D na koncu kode produkta.

ROLLER

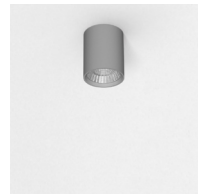

- Aluminijasto ohišje, prašno barvano v izbrani barvi (znotraj in zunaj enake barve pri standardni izvedbi) ali prevlečeno (notranji del v črni barvi).
- Fazni izrez zatemnilnika. (Dimmer phase cut)
- 8W poraba energije pri 350mA.
- CRI: min. 80 / SDCM: 3

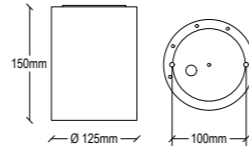
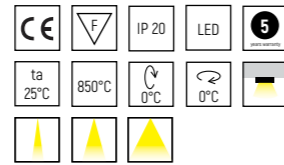

ROLLER 12 SHORT

KODA PRODUKTA: 88008201X
LED 3000K 20W 2000lm 100 lm/W 16° H 150mm 1,200kg

KODA PRODUKTA: 88008301X
LED 4000K 20W 21060m 105 lm/W 16° H 150mm 1,200kg

KODA PRODUKTA: 88008202X
LED 3000K 20W 2000lm 100 lm/W 21° H 150mm 1,200kg

KODA PRODUKTA: 88008302X
LED 4000K 20W 2050lm 104 lm/W 21° H 150mm 1,200kg

KODA PRODUKTA: 88008203X
LED 3000K 20W 2000lm 101 lm/W 40° H 150mm 1,200kg

KODA PRODUKTA: 88008303X
LED 4000K 20W 2100lm 107 lm/W 40° H 150mm 1,200kg

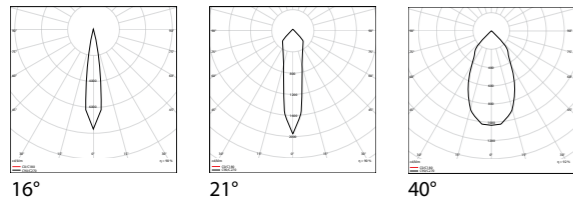

ROLLER

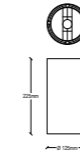

- Aluminijasto ohišje, prašno barvano v izbrani barvi ali prevlečeno.
- 19W poraba energije pri 500mA.
- CRI: min. 80 / SDCM: 3

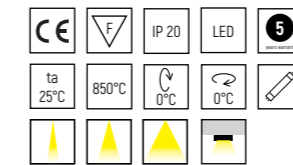
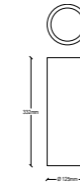
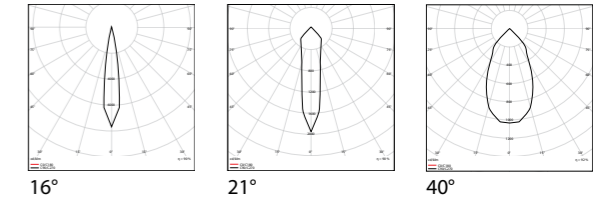

ROLLER 12 LED CHIP

KODA PRODUKTA: 88027201X_
3000K 19W 2490lm 131 lm/W 16° Ø 125mm, H 332mm 3,100kg

KODA PRODUKTA: 88027301X_
4000K 19W 2650lm 140 lm/W 16° Ø 125mm, H 332mm 3,100kg

KODA PRODUKTA: 88027202X_
3000K 19W 2400lm 128 lm/W 21° Ø 125mm, H 332mm 3,100kg

KODA PRODUKTA: 88027302X_
4000K 19W 260lm 137 lm/W 21° Ø 125mm, H 332mm 3,100kg

KODA PRODUKTA: 88027203X_
3000K 19W 2500lm 133 lm/W 40° Ø 125mm, H 332mm 3,100kg

KODA PRODUKTA: 88027303X_
4000K 19W 2700lm 142 lm/W 40° Ø 125mm, H 332mm 3,100kg

ROLLER 12 LED LAMP

KODA PRODUKTA: 88024X
LED max. PAR30/E27 1x100W Ø 125mm, H 332mm 1,400kg

KODA PRODUKTA: 88025X
LED max. R111/G53 1x50W Ø 125mm, H 225mm 1,350kg

KODA PRODUKTA: 88026X
LED R111/GU10 Ø 125mm, H 225mm 1,350kg

DOPOLNITEV KODE PRODUKTA:

X = BARVA

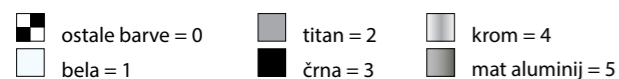

_ = D (dimmer)

Za svetilo z možnostjo zatemnitve (dimmer) dodajte črko D na koncu kode produkta.

DOPOLNITEV KODE PRODUKTA:

X = BARVA



_ = D (dimmer)

Za svetilo z možnostjo zatemnitve (dimmer) dodajte črko D na koncu kode produkta.

ROLLER

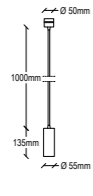
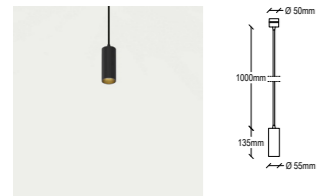

- Aluminijasto ohišje, prašno barvano v izbrani barvi (znotraj in zunaj enake barve pri standardni izvedbi) ali prevlečeno (notranji del v črni barvi).
- Aluminijasta rozeta ø50 mm.
- 1 m viseči kabel, nastavljiv.
- 8W poraba energije pri 350mA.
- CRI: min. 80 / SDCM: 3

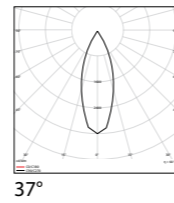
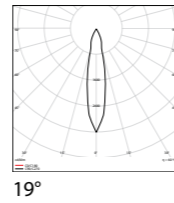
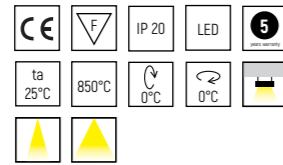
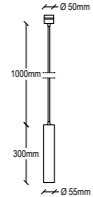
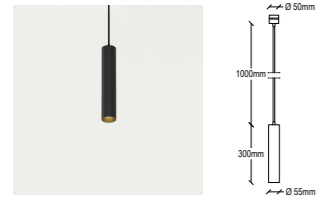

ROLLER 6 - VISEČA

KODA PRODUKTA: 88821202X	LED 3000K	8W	800lm	100lm/W	19°	H 135mm	0,700kg
KODA PRODUKTA: 88821302X	LED 4000K	8W	800lm	100lm/W	19°	H 135mm	0,700kg
KODA PRODUKTA: 88821203X	LED 3000K	8W	800lm	100lm/W	37°	H 135mm	0,700kg
KODA PRODUKTA: 88821303X	LED 4000K	8W	800lm	100lm/W	37°	H 135mm	0,700kg
KODA PRODUKTA: 88828202X	LED 3000K	8W	800lm	100lm/W	19°	H 300mm	1,000kg
KODA PRODUKTA: 88828302X	LED 4000K	8W	800lm	100lm/W	19°	H 300mm	1,000kg
KODA PRODUKTA: 88828203X	LED 3000K	8W	800lm	100lm/W	37°	H 300mm	1,000kg
KODA PRODUKTA: 88828303X	LED 4000K	8W	800lm	100lm/W	37°	H 300mm	1,000kg

DOPOLNITEV KODE PRODUKTA:

X = BARVA

	ostale barve = 0		titan = 2		krom = 4
	bela = 1		črna = 3		mat aluminij = 5

_ = D (dimmer)

Za svetilo z možnostjo zatemnitve (dimmer) dodajte črko D na koncu kode produkta.

ROLLER

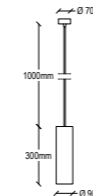
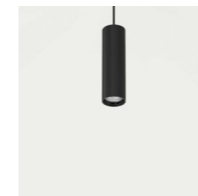

- Aluminijasto ohišje, prašno barvano v izbrani barvi ali prevlečeno.
- 230V/50Hz modul.
- Fazni izrez zatemnilnika.
- CRI: min. 80 / SDCM: 3

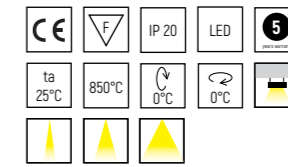

ROLLER 9 REFLEKTOR - VISEČA

KODA PRODUKTA: 88822201X	LED 3000K	20W	2000lm	100 lm/W	18°	H 300mm	1,500kg
KODA PRODUKTA: 88822301X	LED 4000K	20W	2100lm	106 lm/W	18°	H 300mm	1,500kg
KODA PRODUKTA: 88822202X	LED 3000K	20W	2000lm	100 lm/W	26°	H 300mm	1,500kg
KODA PRODUKTA: 88822302X	LED 4000K	20W	2000lm	103 lm/W	26°	H 300mm	1,500kg
KODA PRODUKTA: 88822203X	LED 3000K	20W	2000lm	100 lm/W	45°	H 300mm	1,500kg
KODA PRODUKTA: 88822303X	LED 4000K	20W	2050lm	104 lm/W	45°	H 300mm	1,500kg

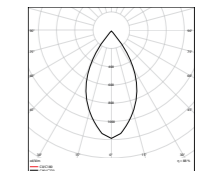
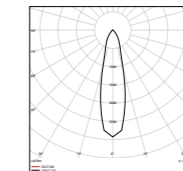
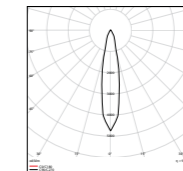

REFLEKTOR
18°

REFLEKTOR
26°

REFLEKTOR
45°

ROLLER 9 LEČA - VISEČA

KODA PRODUKTA: 88823202X	LED 3000K	20W	2000lm	100 lm/W	27°	H 300mm	1,500kg
KODA PRODUKTA: 88823302X	LED 4000K	20W	2000lm	100 lm/W	27°	H 300mm	1,500kg
KODA PRODUKTA: 88823203X	LED 3000K	20W	2000lm	100 lm/W	33°	H 300mm	1,500kg
KODA PRODUKTA: 88823303X	LED 4000K	20W	2000lm	100 lm/W	33°	H 300mm	1,500kg

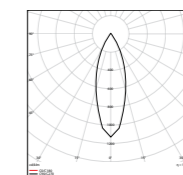
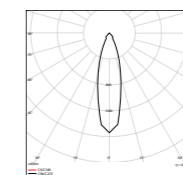

LEČA
27°

LEČA
33°

DOPOLNITEV KODE PRODUKTA:

X = BARVA

	ostale barve = 0		titan = 2		krom = 4
	bela = 1		črna = 3		mat aluminij = 5

_ = D (dimmer)

Za svetilo z možnostjo zatemnitve (dimmer) dodajte črko D na koncu kode produkta.

ROLLER

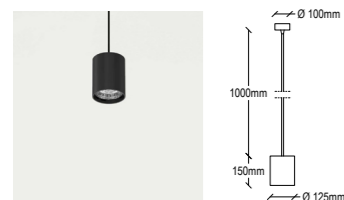

- Aluminijasto ohišje, prašno barvano v izbrani barvi ali prevlečeno.
- Aluminijasta rozeta ø100mm.
- 1 m viseči kabel, nastavljiv.
- 230V/50Hz modul.
- Fazni izrez zatemnilnika.
- CRI: min. 80 / SDCM: 3

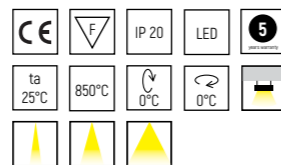

ROLLER 12 SHORT - VISEČA

KODA PRODUKTA: 88824201X
LED 3000K 20W 2000lm 100 lm/W 16° Ø 125mm, H 150mm 1,200kg

KODA PRODUKTA: 88824301X
LED 4000K 20W 2100lm 105 lm/W 16° Ø 125mm, H 150mm 1,200kg

KODA PRODUKTA: 88824202X
LED 3000K 20W 2000lm 100 lm/W 21° Ø 125mm, H 150mm 1,200kg

KODA PRODUKTA: 88824302X
LED 4000K 20W 2050lm 104 lm/W 21° Ø 125mm, H 150mm 1,200kg

KODA PRODUKTA: 88824203X
LED 3000K 20W 2000lm 101 lm/W 40° Ø 125mm, H 150mm 1,200kg

KODA PRODUKTA: 88824303X
LED 4000K 20W 2100lm 107 lm/W 40° Ø 125mm, H 150mm 1,200kg

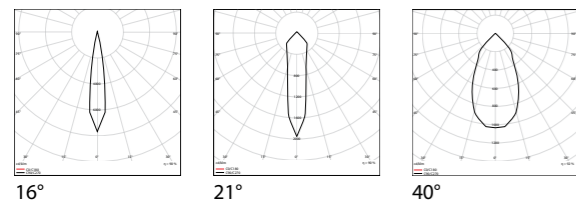

16°

21°

40°

ROLLER



- Aluminijasto ohišje, prašno barvano v izbrani barvi ali prevlečeno.
- 19W poraba energije pri 500mA.
- CRI: min. 80 / SDCM: 3

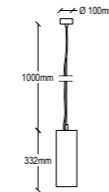
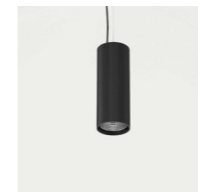
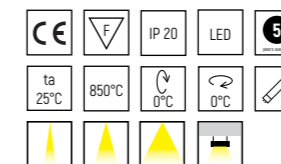

ROLLER 12 LED CHIP - VISEČA

KODA PRODUKTA: 88827201X_
3000K 19W 2490lm 131 lm/W 16° Ø 125mm, H 332mm 3,100kg

KODA PRODUKTA: 88827301X_
4000K 19W 2650lm 140 lm/W 16° Ø 125mm, H 332mm 3,100kg

KODA PRODUKTA: 88827202X_
3000K 19W 2400lm 128 lm/W 21° Ø 125mm, H 332mm 3,100kg

KODA PRODUKTA: 88827302X_
4000K 19W 2600lm 137 lm/W 21° Ø 125mm, H 332mm 3,100kg

KODA PRODUKTA: 88827203X_
3000K 19W 2500lm 133 lm/W 40° Ø 125mm, H 332mm 3,100kg

KODA PRODUKTA: 88827303X_
4000K 19W 2700lm 142 lm/W 40° Ø 125mm, H 332mm 3,100kg

ROLLER 12 LED LAMP - VISEČA

KODA PRODUKTA: 88829X
LED max. PAR30/E27 1x100W Ø 125mm, H 332mm 1,400kg

KODA PRODUKTA: 88825X
LED max. R111/G53 1x50W Ø 125mm, H 225mm 1,350kg

KODA PRODUKTA: 88826X
LED R111/GU10 Ø 125mm, H 225mm 1,350kg

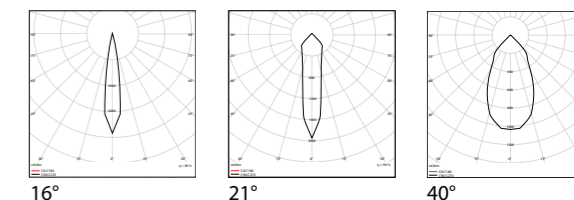

16°

21°

40°

DOPOLNITEV KODE PRODUKTA:

X = BARVA



_ = D (dimmer)

Za svetilo z možnostjo zatemnitve (dimmer) dodajte črko D na koncu kode produkta.

DOPOLNITEV KODE PRODUKTA:

X = BARVA

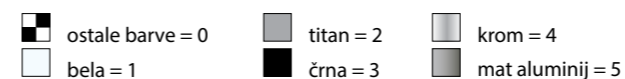

_ = D (dimmer)

Za svetilo z možnostjo zatemnitve (dimmer) dodajte črko D na koncu kode produkta.

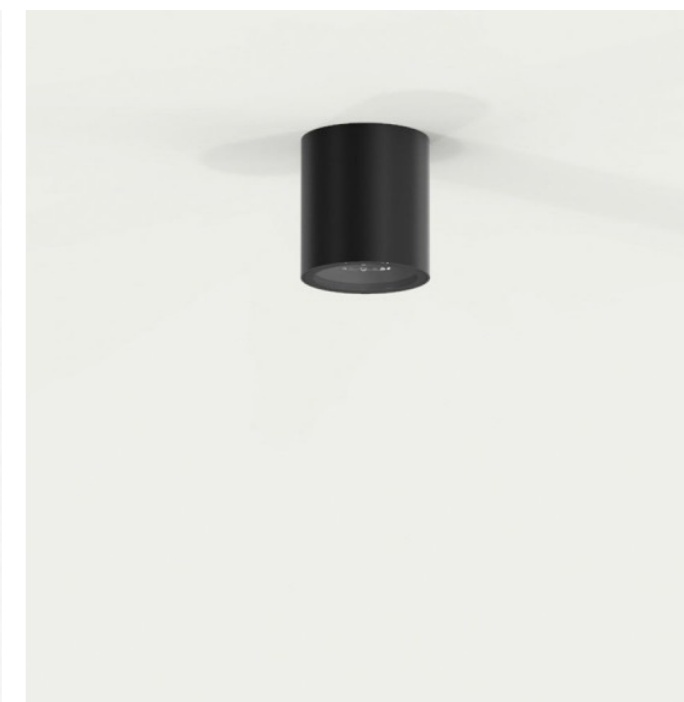

ROLLER je stropna nadgradna ali viseča svetilka cilindrične oblike. Zaradi visoke stopnje zaščite (IP54 in IP65) je primerna za zunanjo razsvetljavo.

TEHNIČNI PODATKI IN LASTNOSTI

- Aluminijasto ohišje.
- Visoko učinkoviti reflektorji na voljo v različicah s srednje širokim in širokim snopom svetlobe.
- Čista svetloba brez IR/UV sevanja.
- Učinkovito toplotno upravljanje.
- Življenjska doba delovanja: 50.000 ur z izkoristkom > 80% začetnega svetlobnega toka (L80B10).

NA ZAHTEVO

- Na voljo z višjim indeksom barvnega upodabljanja (CRI).

KARAKTERISTIKE

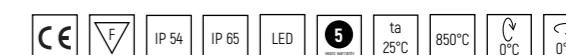

NAČIN PRITRDNITVE SVETILA



NAČIN OSVETLITVE



BARVE

- bela
- titan
- črna
- ostale barve

POVRŠINSKE OBDELAVE

- krom
- mat aluminij

ROLLER

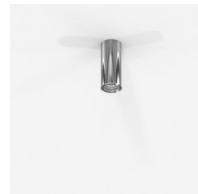

- Aluminijasto ohišje, prašno barvano v izbrani barvi ali prevlečeno.
- Kaljeno zaščitno steklo.
- Silikonsko tesnilo.
- CRI: min. 80 / SCDM: 3

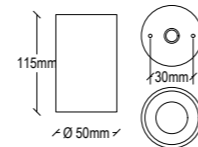
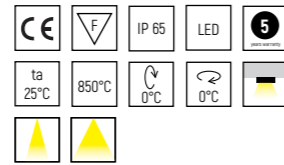

ROLLER MINI 5 IP65

KODA PRODUKTA: 88006202X
LED 3000K IP65 5W 500lm 100lm/W 23° Ø 50mm, H 127mm 0,700kg

KODA PRODUKTA: 88006302X
LED 4000K IP65 5W 500lm 100lm/W 23° Ø 50mm, H 127mm 0,700kg

KODA PRODUKTA: 88006203X
LED 3000K IP65 5W 500lm 100lm/W 45° Ø 50mm, H 127mm 0,700kg

KODA PRODUKTA: 88006303X
LED 4000K IP65 5W 500lm 100lm/W 45° Ø 50mm, H 127mm 0,700kg

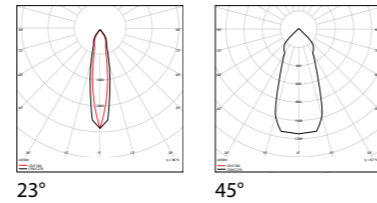

ROLLER



- Aluminijasto ohišje, prašno barvano v izbrani barvi ali prevlečeno.
- Kaljeno zaščitno steklo.
- LED svetilka GU10.

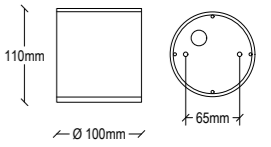
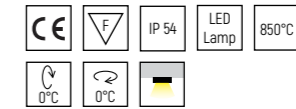

ROLLER 10 IP54

KODA PRODUKTA: 88049X
LED GU10 IP54 Ø 100mm, H 110mm 0,600kg

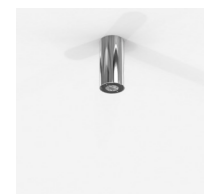

- Aluminijasto ohišje, prašno barvano v izbrani barvi ali prevlečeno.
- Kaljeno zaščitno steklo.
- Silikonsko tesnilo.
- CRI: min. 80 / SCDM: 3

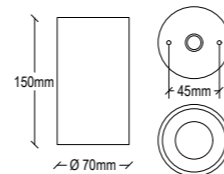
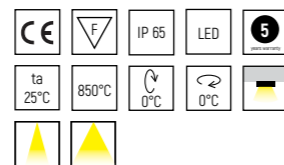

ROLLER MINI 7 IP65

KODA PRODUKTA: 88007202X
LED 3000K IP65 8W 890lm 112 lm/W 23° Ø 70mm, H 160mm 1,000kg

KODA PRODUKTA: 88007302X
LED 4000K IP65 8W 925lm 116 lm/W 23° Ø 70mm, H 160mm 1,000kg

KODA PRODUKTA: 88007203X
LED 3000K IP65 8W 860lm 109 lm/W 45° Ø 70mm, H 160mm 1,000kg

KODA PRODUKTA: 88007303X
LED 4000K IP65 8W 890lm 112 lm/W 45° Ø 70mm, H 160mm 1,000kg

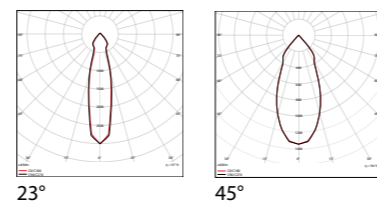

- Aluminijasto ohišje, prašno barvano v izbrani barvi ali prevlečeno.
- Kaljeno zaščitno steklo.
- 230V/50Hz modul.
- Fazni izrez zatemnilnika.
- CRI: min. 80 / SDCM: 3

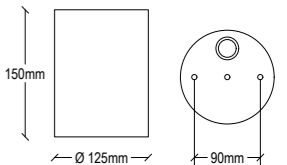
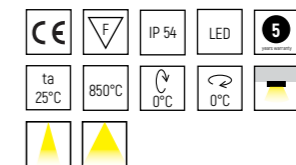

ROLLER 12 SHORT IP54

KODA PRODUKTA: 88019202X
LED 3000K IP54 20W 2000lm 100 lm/W sr. širok žarek Ø 125mm, H 150mm 1,500kg

KODA PRODUKTA: 88019302X
LED 4000K IP54 20W 2000lm 100 lm/W sr. širok žarek Ø 125mm, H 150mm 1,500kg

KODA PRODUKTA: 88019203X
LED 3000K IP54 20W 2000lm 100 lm/W širok žarek Ø 125mm, H 150mm 1,500kg

KODA PRODUKTA: 88019303X
LED 4000K IP54 20W 2000lm 100 lm/W širok žarek Ø 125mm, H 150mm 1,500kg

DOPOLNITEV KODE PRODUKTA:

X = BARVA

- ostale barve = 0
- titan = 2
- krom = 4
- bela = 1
- črna = 3
- mat aluminij = 5

DOPOLNITEV KODE PRODUKTA:

X = BARVA

- ostale barve = 0
- titan = 2
- krom = 4
- bela = 1
- črna = 3
- mat aluminij = 5



EASYLINE

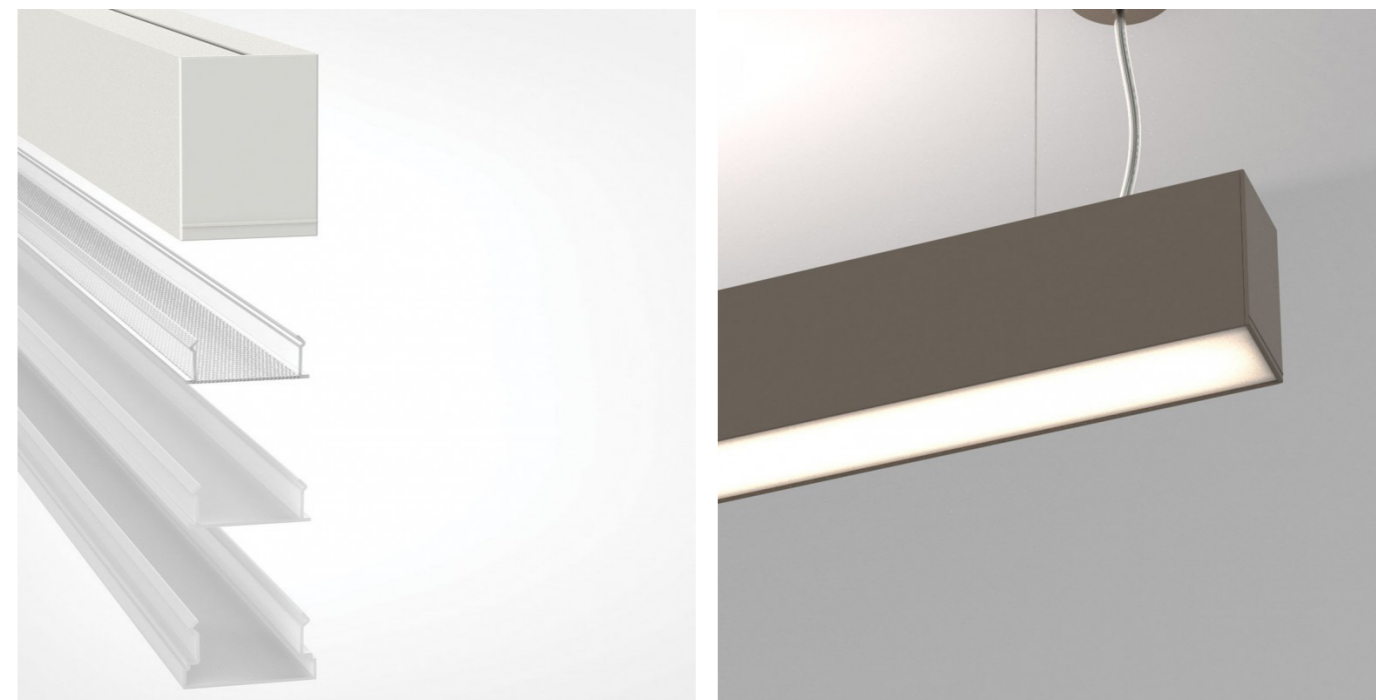

EASYLINE svetilka združuje učinkovitost s sodobnim dizajnom. Ustvarja popolne svetlobne pogoje brez neprijetnih odsevov in je zato primerno za uporabo od vhodnih prostorov do pisarn. Zaradi sistema nizanja (continuous-row system) je osvetljenost popolnoma enakomerna od začetka do konca. Svetilo je ekonomsko učinkovito, ne potrebuje vzdrževanja in ima dolgotrajno življenjsko dobo.

TEHNIČNI PODATKI IN LASTNOSTI

- Ohišje iz aluminijastega profila, lakirano elektrostatskično v izbrani barvi.
- PMMA difuzor v opalu, mikroprizmatični, mikroprizmatični opal, v anaglifni izdaji ali z barvanim aluminijastim pokrovom.
- Odstranljive plastične glave.
- Čista svetloba brez IR/UV sevanja.
- Učinkovito toplotno upravljanje.
- Razpon svetlobnega toka do 28 W/m in 5000 Lm.
- UGR<19 pri mikroprizmatičnih in mikroprizmatičnih različicah opala: Ocena bleščanja: X=4H/ Y=8H S=0,25H, faktor odboja 70/50/20. Za delovne postaje DSE: $\gamma \geq 650 < 3000 \text{cd/m}^2$.
- Življenjska doba delovanja: 50.000 ur z izkoristkom > 80 % začetnega svetlobnega toka (L80B10).
- Prikluček za delovanje na 230V-50/60Hz.
- Na voljo kot stropno ali viseče svetilo.

NA ZAHTEVO

- Prikluček za sistem zasilne razsvetljave, za eno ali tri ure.
- Na voljo z višjim indeksom barvnega upodabljanja (CRI).
- Na voljo v različici zaščite IP54.

KARAKTERISTIKE

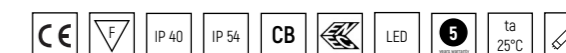

NAČIN PRITRDNITVE SVETILA



BARVE

- bela
- titan
- črna
- ostale barve

POVRŠINSKE OBDELAVE

- eloksirano

- Ohišje iz ekstrudiranega aluminijastega profila.



EASYLINE TRUNKING SURFACE

KODA PRODUKTA: 9931LX
1,700kg

- Opalni difuzor PMMA za IP40.



EASYLINE COVER OPAL

KODA PRODUKTA: 9951L1
0,250kg

- Mikroprizmatični difuzor PMMA za IP40.

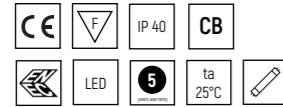

EASYLINE COVER MICROPRISMATIC

KODA PRODUKTA: 9952L1
0,250kg

- Mikroprizmatični opalni difuzor PMMA za IP40.



EASYLINE COVER MICROPRISMATIC OPAL

KODA PRODUKTA: 9958L1
0,250kg

- Anaglifni difuzor PMMA za IP40.



EASYLINE COVER ANAGLYPH

KODA PRODUKTA: 9953L1
0,250kg

- Barvan aluminijast pokrov za IP40.



EASYLINE COVER ALUMINIUM BLIND

KODA PRODUKTA: 995401X
0,500kg

- Opalni difuzor PMMA za IP54.

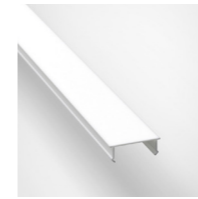

EASYLINE COVER OPAL IP54

KODA PRODUKTA: 9955L1
0,250kg

- Mikroprizmatični difuzor PMMA za IP54.

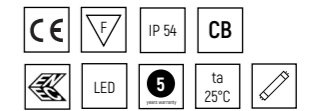

EASYLINE COVER MICROPRISMATIC IP54

KODA PRODUKTA: 9956L1
0,250kg

- Mikroprizmatični opalni difuzor PMMA za IP54.

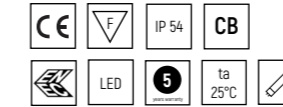

EASYLINE COVER MICROPRISMATIC OPAL IP54

KODA PRODUKTA: 9959L1
0,250kg

- Anaglifni difuzor PMMA za IP54.

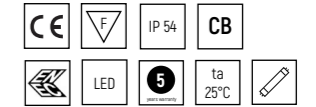

EASYLINE COVER ANAGLYPH IP54

KODA PRODUKTA: 9957L1
0,250kg

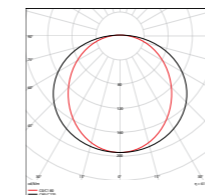

OPAL

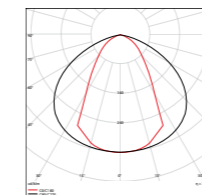

MICROPRISMATIC

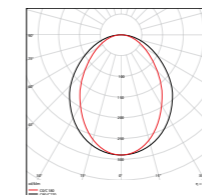

MICROPRISMATIC OPAL

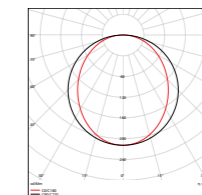

ANAGLYPH

DOPOLNITEV KODE PRODUKTA:

X = BARVA



L = DOLŽINA

01 = custom 03 = 864mm 05 = 1424mm 07 = 1984mm 09 = 2548mm
02 = 584mm 04 = 1144mm 06 = 1704mm 08 = 2264mm 10 = 2828mm

DOPOLNITEV KODE PRODUKTA:

X = BARVA



L = DOLŽINA

01 = custom 03 = 864mm 05 = 1424mm 07 = 1984mm 09 = 2548mm
02 = 584mm 04 = 1144mm 06 = 1704mm 08 = 2264mm 10 = 2828mm



- Plastični pokrov brez vijakov.
- Količina: v paru.



EASYLINE SURFACE PLASTIČNI ZAKLJUČNI POKROV

KODA PRODUKTA: 99611X
0,010kg



- Plastični pokrov brez vijakov.
- Količina: v paru.



EASYLINE PLASTIČNI ZAKLJUČNI POKROV ANAGLYPH SURFACE

KODA PRODUKTA: 99613X
0,010kg



- Aluminijast končni pokrov brez vijakov.
- Količina: v paru.



EASYLINE SURFACE ALUMINIJSKI ZAKLJUČNI POKROV

KODA PRODUKTA: 99615X
0,030kg



- Aluminijast končni pokrov brez vijakov.
- Količina: v paru.



EASYLINE ALUMINIJSKI ZAKLJUČNI POKROV ANAGLYPH SURFACE

KODA PRODUKTA: 99616X
0,030kg



- Aluminijasti priključki za kanale.
- Količina: v paru.



POVEZOVALNI KONEKTOR

KODA PRODUKTA: 968255

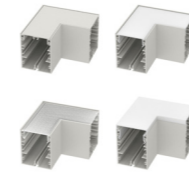

- Ohišje iz ekstrudiranega aluminijastega profila.
- PMMA difuzor v opalu, mikroprizmatični, mikroprizmatični opalni ali anaglifni z barvanim aluminijastim pokrovom za IP40.

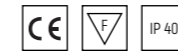

L KONEKTOR 120x120

KODA PRODUKTA: 996211X
metal blind

KODA PRODUKTA: 996212X
opal

KODA PRODUKTA: 996213X
microprismatic

KODA PRODUKTA: 996218X
microprismatic opal

KODA PRODUKTA: 996214X
anaglyph



- Ohišje iz ekstrudiranega aluminijastega profila, anodiziranega.
- PMMA prozoren pokrov.
- CRI: min. 80 / SDCM: 3
- Svetlobna učinkovitost - Visoka učinkovitost: 183 lm/W (4000 K)
- Svetlobna učinkovitost - Visoka moč: 175 lm/W (3000 K)
- Svetlobna učinkovitost - Visoka moč: 174 lm/W (4000 K)
- Svetlobna učinkovitost - Visoka moč: 166 lm/W (3000 K)

LED MODUL - VISOKA UČINKOVITOST

KODA PRODUKTA: 994Y01
10W L 564mm

KODA PRODUKTA: 994Y02
15W L 844mm

KODA PRODUKTA: 994TY03
20W L 1124mm

KODA PRODUKTA: 994TY04
25W L 1404mm

KODA PRODUKTA: 994TY05
30W L 1684mm

KODA PRODUKTA: 994TY06
35W L 1964mm

KODA PRODUKTA: 994TY07
40W L 2244mm

*Emergency type option not possible at L564mm and L844mm

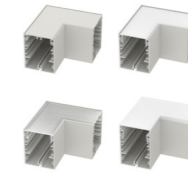

- Ohišje iz ekstrudiranega aluminijastega profila.
- PMMA difuzor v opalu, mikroprizmatični, mikroprizmatični opalni ali anaglifni za IP54.

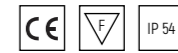

L KONEKTOR 120x120 IP54

KODA PRODUKTA: 996215X
opal IP54

KODA PRODUKTA: 996216X
microprismatic IP54

KODA PRODUKTA: 996219X
microprismatic opal IP54

KODA PRODUKTA: 996217X
anaglyph IP54

- Dodatne tehnične podrobnosti:
- Enostavna namestitvev brez orodja.
 - Neprekinjene svetlobne linije brez črnih pik.
 - Na zahtevo: predhodno ožičeno za standardno, dali ali izdajo v sili.



LED MODUL - VISOKA MOČ

KODA PRODUKTA: 994Y11
16W L 564mm

KODA PRODUKTA: 994Y12
24W L 844mm

KODA PRODUKTA: 994TY13
32W L 1124mm

KODA PRODUKTA: 994TY14
40W L 1404mm

KODA PRODUKTA: 994TY15
48W L 1684mm

KODA PRODUKTA: 994TY16
56W L 1964mm

KODA PRODUKTA: 994TY17
64W L 2244mm

*Emergency type option not possible at L564mm and L844mm

DOPOLNITEV KODE PRODUKTA:

X = BARVA

- ostale barve = 0
- titan = 2
- eloks. = 9
- bela = 1
- črna = 3

DOPOLNITEV KODE PRODUKTA:

- Y = LED
- 5000K (cool) = 1
- 3000K (warm) = 2
- 4000K (neutral) = 3
- T = TIP
- Electronic = 1
- Dimmer = 2
- Emergency* = 3

EASYLINE UP/DOWN



- Aluminijasto ohišje.
- Odstranljive plastične glave.
- Visoko učinkovit opalni difuzor PMMA za neposredno osvetlitev.
- Opal PMMA difuzor za indirektno osvetlitev.
- Viseče obešalo in napajalnik nista priložena.
- CRI: min. 80 / SDCM: 3

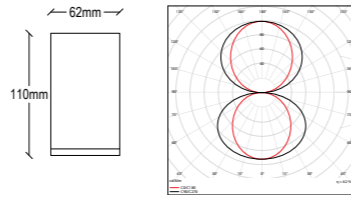
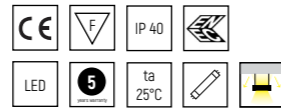

EASYLINE UP/DOWN OPAL

KODA PRODUKTA: 9903T201X	3000K	15+10W	2700lm	111lm/W	L 870mm	3,600kg/m
KODA PRODUKTA: 9903T301X	4000K	15+10W	2800lm	116lm/W	L 870mm	3,600kg/m
KODA PRODUKTA: 9903T202X	3000K	20+15W	3870lm	111lm/W	L 1150mm	3,600kg/m
KODA PRODUKTA: 9903T302X	4000K	20+15W	4000lm	116lm/W	L 1150mm	3,600kg/m
KODA PRODUKTA: 9903T203X	3000K	25+20W	4900lm	111lm/W	L 1430mm	3,600kg/m
KODA PRODUKTA: 9903T303X	4000K	25+20W	5100lm	116lm/W	L 1430mm	3,600kg/m
KODA PRODUKTA: 9903T204X	3000K	30+25W	6000lm	111lm/W	L 1710mm	3,600kg/m
KODA PRODUKTA: 9903T304X	4000K	30+25W	6300lm	116lm/W	L 1710mm	3,600kg/m
KODA PRODUKTA: 9903T205X	3000K	35+30W	7100lm	111lm/W	L 1990mm	3,600kg/m
KODA PRODUKTA: 9903T305X	4000K	35+30W	7500lm	116lm/W	L 1990mm	3,600kg/m
KODA PRODUKTA: 9903T206X	3000K	40+30W	7700lm	110lm/W	L 2270mm	3,600kg/m
KODA PRODUKTA: 9903T306X	4000K	40+30W	8000lm	115lm/W	L 2270mm	3,600kg/m
KODA PRODUKTA: 9903T207X	3000K	45+35W	8800lm	110lm/W	L 2556mm	3,600kg/m
KODA PRODUKTA: 9903T307X	4000K	45+35W	9220lm	115lm/W	L 2556mm	3,600kg/m
KODA PRODUKTA: 9903T208X	3000K	50+40W	9900lm	110lm/W	L 2836mm	3,600kg/m
KODA PRODUKTA: 9903T308X	4000K	50+40W	10300lm	115lm/W	L 2836mm	3,600kg/m

EASYLINE UP/DOWN OPAL

KODA PRODUKTA: 9903T209X	3000K	24+16W	4100lm	105lm/W	L 870mm	3,600kg/m
KODA PRODUKTA: 9903T309X	4000K	24+16W	4300lm	110lm/W	L 870mm	3,600kg/m
KODA PRODUKTA: 9903T210X	3000K	32+24W	5800lm	105lm/W	L 1150mm	3,600kg/m
KODA PRODUKTA: 9903T310X	4000K	32+24W	6100lm	110lm/W	L 1150mm	3,600kg/m
KODA PRODUKTA: 9903T211X	3000K	40+32W	7500lm	105lm/W	L 1430mm	3,600kg/m
KODA PRODUKTA: 9903T311X	4000K	40+32W	7800lm	110lm/W	L 1430mm	3,600kg/m
KODA PRODUKTA: 9903T212X	3000K	48+40W	9200lm	105lm/W	L 1710mm	3,600kg/m
KODA PRODUKTA: 9903T312X	4000K	48+40W	9600lm	110lm/W	L 1710mm	3,600kg/m
KODA PRODUKTA: 9903T213X	3000K	56+48W	10900lm	105lm/W	L 1990mm	3,600kg/m
KODA PRODUKTA: 9903T313X	4000K	56+48W	11300lm	110lm/W	L 1990mm	3,600kg/m
KODA PRODUKTA: 9903T214X	3000K	64+48W	11700lm	105lm/W	L 2270mm	3,600kg/m
KODA PRODUKTA: 9903T314X	4000K	64+48W	12200lm	109lm/W	L 2270mm	3,600kg/m
KODA PRODUKTA: 9903T215X	3000K	72+56W	13300lm	105lm/W	L 2556mm	3,600kg/m
KODA PRODUKTA: 9903T315X	4000K	72+56W	13900lm	109lm/W	L 2556mm	3,600kg/m
KODA PRODUKTA: 9903T216X	3000K	80+64W	15000lm	105lm/W	L 2836mm	3,600kg/m
KODA PRODUKTA: 9903T316X	4000K	80+64W	15700lm	109lm/W	L 2836mm	3,600kg/m

DOPOLNITEV KODE PRODUKTA:

- X = BARVA
- ostale barve = 0 titan = 2 eloks. = 9 T = TIP Electronic = 1
- bela = 1 črna = 3 Dimmer = 2

EASYLINE UP/DOWN



- Aluminijasto ohišje.
- Odstranljive plastične glave.
- Visoko učinkovit mikroprizmatični difuzor PMMA za neposredno osvetlitev.
- Viseče obešalo in napajalnik nista priložena.
- CRI: min. 80 / SDCM: 3

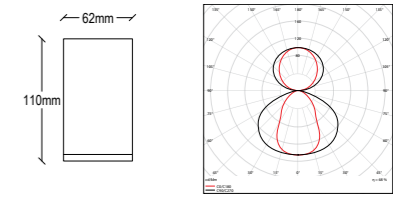

EASYLINE UP/DOWN MICROPRISMATIC

KODA PRODUKTA: 9913T201X	3000K	15+10W	3000lm	121lm/W	L 870mm	3,600kg/m
KODA PRODUKTA: 9913T301X	4000K	15+10W	3100lm	126lm/W	L 870mm	3,600kg/m
KODA PRODUKTA: 9913T202X	3000K	20+15W	4200lm	121lm/W	L 1150mm	3,600kg/m
KODA PRODUKTA: 9913T302X	4000K	20+15W	440lm	126lm/W	L 1150mm	3,600kg/m
KODA PRODUKTA: 9913T203X	3000K	25+20W	5400lm	121lm/W	L 1430mm	3,600kg/m
KODA PRODUKTA: 9913T303X	4000K	25+20W	5600lm	126lm/W	L 1430mm	3,600kg/m
KODA PRODUKTA: 9913T204X	3000K	30+25W	6640lm	121lm/W	L 1710mm	3,600kg/m
KODA PRODUKTA: 9913T304X	4000K	30+25W	6900lm	126lm/W	L 1710mm	3,600kg/m
KODA PRODUKTA: 9913T205X	3000K	35+30W	7800lm	121lm/W	L 1990mm	3,600kg/m
KODA PRODUKTA: 9913T305X	4000K	35+30W	8200lm	126lm/W	L 1990mm	3,600kg/m
KODA PRODUKTA: 9913T206X	3000K	40+30W	8400lm	120lm/W	L 2270mm	3,600kg/m
KODA PRODUKTA: 9913T306X	4000K	40+30W	8700lm	126lm/W	L 2270mm	3,600kg/m
KODA PRODUKTA: 9913T207X	3000K	45+35W	9600lm	120lm/W	L 2556mm	3,600kg/m
KODA PRODUKTA: 9913T307X	4000K	45+35W	10000lm	126lm/W	L 2556mm	3,600kg/m
KODA PRODUKTA: 9913T208X	3000K	50+40W	10800lm	120lm/W	L 2836mm	3,600kg/m
KODA PRODUKTA: 9913T308X	4000K	50+40W	11300lm	126lm/W	L 2836mm	3,600kg/m

EASYLINE UP/DOWN MICROPRISMATIC

KODA PRODUKTA: 9913T209X	3000K	24+16W	4500lm	115lm/W	L 870mm	3,600kg/m
KODA PRODUKTA: 9913T309X	4000K	24+16W	4700lm	120lm/W	L 870mm	3,600kg/m
KODA PRODUKTA: 9913T210X	3000K	32+24W	6400lm	115lm/W	L 1150mm	3,600kg/m
KODA PRODUKTA: 9913T310X	4000K	32+24W	6700lm	120lm/W	L 1150mm	3,600kg/m
KODA PRODUKTA: 9913T211X	3000K	40+32W	8250lm	115lm/W	L 1430mm	3,600kg/m
KODA PRODUKTA: 9913T311X	4000K	40+32W	8600lm	120lm/W	L 1430mm	3,600kg/m
KODA PRODUKTA: 9913T212X	3000K	48+40W	10000lm	115lm/W	L 1710mm	3,600kg/m
KODA PRODUKTA: 9913T312X	4000K	48+40W	10500lm	120lm/W	L 1710mm	3,600kg/m
KODA PRODUKTA: 9913T213X	3000K	56+48W	11900lm	115lm/W	L 1990mm	3,600kg/m
KODA PRODUKTA: 9913T313X	4000K	56+48W	12400lm	120lm/W	L 1990mm	3,600kg/m
KODA PRODUKTA: 9913T214X	3000K	64+48W	12700lm	114lm/W	L 2270mm	3,600kg/m
KODA PRODUKTA: 9913T314X	4000K	64+48W	13300lm	119lm/W	L 2270mm	3,600kg/m
KODA PRODUKTA: 9913T215X	3000K	72+56W	14600lm	114lm/W	L 2556mm	3,600kg/m
KODA PRODUKTA: 9913T315X	4000K	72+56W	15200lm	119lm/W	L 2556mm	3,600kg/m
KODA PRODUKTA: 9913T216X	3000K	80+64W	16400lm	114lm/W	L 2836mm	3,600kg/m
KODA PRODUKTA: 9913T316X	4000K	80+64W	17100lm	119lm/W	L 2836mm	3,600kg/m

DOPOLNITEV KODE PRODUKTA:

- X = BARVA
- ostale barve = 0 titan = 2 eloks. = 9 T = TIP Electronic = 1
- bela = 1 črna = 3 Dimmer = 2

EASYLINE UP/DOWN



- Aluminijasto ohišje.
- Odstranljive plastične glave.
- Visoko učinkovit mikroprizmatični opalni difuzor PMMA za neposredno osvetlitev.
- Viseče obešalo in napajalnik nista priložena.
- CRI: min. 80 / SDCM: 3

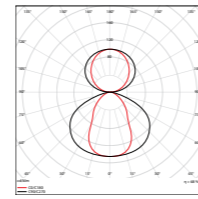
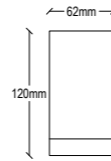

EASYLINE UP/DOWN MICROPRISMATIC OPAL

KODA PRODUKTA: 9933T201X
3000K 15+10W L 870mm 3,600kg/m

KODA PRODUKTA: 9933T301X
4000K 15+10W L 870mm 3,600kg/m

KODA PRODUKTA: 9933T202X
3000K 20+15W L 1150mm 3,600kg/m

KODA PRODUKTA: 9933T302X
4000K 20+15W L 1150mm 3,600kg/m

KODA PRODUKTA: 9933T203X
3000K 25+20W L 1430mm 3,600kg/m

KODA PRODUKTA: 9933T303X
4000K 25+20W L 1430mm 3,600kg/m

KODA PRODUKTA: 9933T204X
3000K 30+25W L 1710mm 3,600kg/m

KODA PRODUKTA: 9933T304X
4000K 30+25W L 1710mm 3,600kg/m

KODA PRODUKTA: 9933T205X
3000K 35+30W L 1990mm 3,600kg/m

KODA PRODUKTA: 9933T305X
4000K 35+30W L 1990mm 3,600kg/m

KODA PRODUKTA: 9933T206X
3000K 40+30W L 2270mm 3,600kg/m

KODA PRODUKTA: 9933T306X
4000K 40+30W L 2270mm 3,600kg/m

KODA PRODUKTA: 9933T207X
3000K 45+35W L 2556mm 3,600kg/m

KODA PRODUKTA: 9933T307X
4000K 45+35W L 2556mm 3,600kg/m

KODA PRODUKTA: 9933T208X
3000K 50+40W L 2836mm 3,600kg/m

KODA PRODUKTA: 9933T308X
4000K 50+40W L 2836mm 3,600kg/m

EASYLINE UP/DOWN MICROPRISMATIC OPAL

KODA PRODUKTA: 9933T209X
3000K 24+16W L 870mm 3,600kg/m

KODA PRODUKTA: 9933T309X
4000K 24+16W L 870mm 3,600kg/m

KODA PRODUKTA: 9933T210X
3000K 32+24W L 1150mm 3,600kg/m

KODA PRODUKTA: 9933T310X
4000K 32+24W L 1150mm 3,600kg/m

KODA PRODUKTA: 9933T211X
3000K 40+32W L 1430mm 3,600kg/m

KODA PRODUKTA: 9933T311X
4000K 40+32W L 1430mm 3,600kg/m

KODA PRODUKTA: 9933T212X
3000K 48+40W L 1710mm 3,600kg/m

KODA PRODUKTA: 9933T312X
4000K 48+40W L 1710mm 3,600kg/m

KODA PRODUKTA: 9933T213X
3000K 56+48W L 1990mm 3,600kg/m

KODA PRODUKTA: 9933T313X
4000K 56+48W L 1990mm 3,600kg/m

KODA PRODUKTA: 9933T214X
3000K 64+48W L 2270mm 3,600kg/m

KODA PRODUKTA: 9933T314X
4000K 64+48W L 2270mm 3,600kg/m

KODA PRODUKTA: 9933T215X
3000K 72+56W L 2556mm 3,600kg/m

KODA PRODUKTA: 9933T315X
4000K 72+56W L 2556mm 3,600kg/m

KODA PRODUKTA: 9933T216X
3000K 80+64W L 2836mm 3,600kg/m

KODA PRODUKTA: 9933T316X
4000K 80+64W L 2836mm 3,600kg/m

DOPOLNITEV KODE PRODUKTA:

X = BARVA

ostale barve = 0 titan = 2 eloks. = 9
bela = 1 črna = 3

T = TIP

Electronic = 1
Dimmer = 2

EASYLINE UP/DOWN

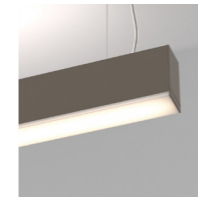

- Aluminijasto ohišje.
- Odstranljive plastične glave.
- Visoko učinkovit anaglifni difuzor PMMA za neposredno osvetlitev.
- Viseče obešalo in napajalnik nista priložena.
- CRI: min. 80 / SDCM: 3

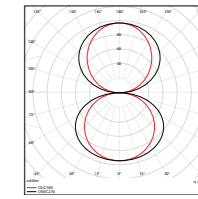
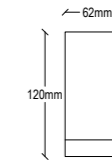
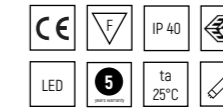

EASYLINE UP/DOWN ANAGLYPH

KODA PRODUKTA: 9923T201X
3000K 15+10W 2700lm 112lm/W L 870mm 3,600kg/m

KODA PRODUKTA: 9923T301X
4000K 15+10W 2900lm 117lm/W L 870mm 3,600kg/m

KODA PRODUKTA: 9923T202X
3000K 20+15W 3900lm 116lm/W L 1150mm 3,600kg/m

KODA PRODUKTA: 9923T302X
4000K 20+15W 4000lm 117lm/W L 1150mm 3,600kg/m

KODA PRODUKTA: 9923T203X
3000K 25+20W 5000lm 112lm/W L 1430mm 3,600kg/m

KODA PRODUKTA: 9923T303X
4000K 25+20W 5200lm 117lm/W L 1430mm 3,600kg/m

KODA PRODUKTA: 9923T204X
3000K 30+25W 6100lm 112lm/W L 1710mm 3,600kg/m

KODA PRODUKTA: 9923T304X
4000K 30+25W 6400lm 117lm/W L 1710mm 3,600kg/m

KODA PRODUKTA: 9923T205X
3000K 35+30W 7200lm 112lm/W L 1990mm 3,600kg/m

KODA PRODUKTA: 9923T305X
4000K 35+30W 7500lm 117lm/W L 1990mm 3,600kg/m

KODA PRODUKTA: 9923T206X
3000K 40+30W 7800lm 117lm/W L 2270mm 3,600kg/m

KODA PRODUKTA: 9923T306X
4000K 40+30W 8100lm 117lm/W L 2270mm 3,600kg/m

KODA PRODUKTA: 9923T207X
3000K 45+35W 8900lm 111lm/W L 2556mm 3,600kg/m

KODA PRODUKTA: 9923T307X
4000K 45+35W 9300lm 117lm/W L 2556mm 3,600kg/m

KODA PRODUKTA: 9923T208X
3000K 50+40W 10000lm 111lm/W L 2836mm 3,600kg/m

KODA PRODUKTA: 9923T308X
4000K 50+40W 10400lm 116lm/W L 2836mm 3,600kg/m

EASYLINE UP/DOWN ANAGLYPH

KODA PRODUKTA: 9923T209X
3000K 24+16W 4232lm 106lm/W L 870mm 3,600kg/m

KODA PRODUKTA: 9923T309X
4000K 24+16W 4400lm 111lm/W L 870mm 3,600kg/m

KODA PRODUKTA: 9923T210X
3000K 32+24W 5900lm 106lm/W L 1150mm 3,600kg/m

KODA PRODUKTA: 9923T310X
4000K 32+24W 6100lm 111lm/W L 1150mm 3,600kg/m

KODA PRODUKTA: 9923T211X
3000K 40+32W 7600lm 106lm/W L 1430mm 3,600kg/m

KODA PRODUKTA: 9923T311X
4000K 40+32W 7900lm 111lm/W L 1430mm 3,600kg/m

KODA PRODUKTA: 9923T212X
3000K 48+40W 9300lm 106lm/W L 1710mm 3,600kg/m

KODA PRODUKTA: 9923T312X
4000K 48+40W 9700lm 116lm/W L 1710mm 3,600kg/m

KODA PRODUKTA: 9923T213X
3000K 56+48W 11000lm 106lm/W L 1990mm 3,600kg/m

KODA PRODUKTA: 9923T313X
4000K 56+48W 11400lm 111lm/W L 1990mm 3,600kg/m

KODA PRODUKTA: 9923T214X
3000K 64+48W 11800lm 106lm/W L 2270mm 3,600kg/m

KODA PRODUKTA: 9923T314X
4000K 64+48W 12300lm 111lm/W L 2270mm 3,600kg/m

KODA PRODUKTA: 9923T215X
3000K 72+56W 13500lm 106lm/W L 2556mm 3,600kg/m

KODA PRODUKTA: 9923T315X
4000K 72+56W 14100lm 110lm/W L 2556mm 3,600kg/m

KODA PRODUKTA: 9923T216X
3000K 80+64W 15200lm 106lm/W L 2836mm 3,600kg/m

KODA PRODUKTA: 9923T316X
4000K 80+64W 15800lm 110lm/W L 2836mm 3,600kg/m

DOPOLNITEV KODE PRODUKTA:

X = BARVA

ostale barve = 0 titan = 2 eloks. = 9
bela = 1 črna = 3

T = TIP

Electronic = 1
Dimmer = 2



EASYLINE UP/DOWN

STANDARDNA VERZIJA

Močna indirektna osvetlitev v različnih izvedbah LED bele barve za prostore z zahtevnimi potrebami po osvetlitvi.

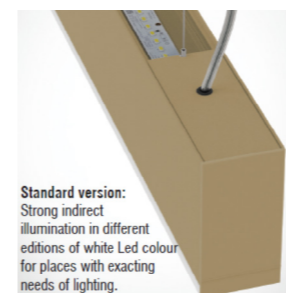

Standard version:
Strong indirect illumination in different editions of white Led colour for places with exacting needs of lighting.

NA ZAHTEVO

Mehka indirektna barvna osvetlitev ali RGB LED trak verzija za bolj specifične svetlobne rešitve v sodobnih prostorih.

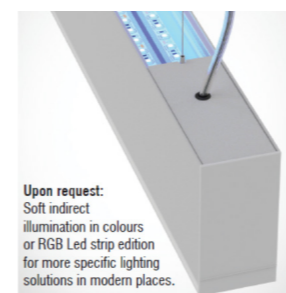

Upon request:
Soft indirect illumination in colours or RGB Led strip edition for more specific lighting solutions in modern places.

NA ZAHTEVO

Z možnostjo posebne kotne osvetlitve s točkovno osvetlitvijo.



Upon request:
With the ability of particular lighting corner edition with spot lighting.

NA ZAHTEVO

Z možnostjo posebne kotne osvetlitve.

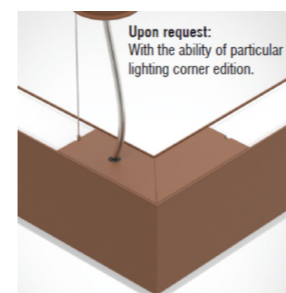

Upon request:
With the ability of particular lighting corner edition.

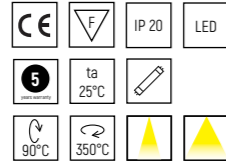

- Aluminijasto ohišje.
- Reflektor ali leča s snopom svetlobe v srednji in široki različici.
- 7W poraba energije pri 350mA.
- CRI: min. 80 / SDCM: 3
- Svetlobna učinkovitost pri 7 W:
112 lm/W (3000 K)
117 lm/W (4000 K)

SPOT ADJUSTABLE REFLEKTOR

KODA PRODUKTA: 99631YZX
LED 7W 0,400kg

KODA PRODUKTA: 99632YZX
LED 2x7W 0,700kg

SPOT ADJUSTABLE LEČA

KODA PRODUKTA: 99633YZX
LED 7W 0,400kg

KODA PRODUKTA: 99634YZX
LED 2x7W 0,700kg

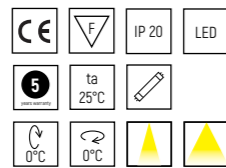

- Aluminijasto ohišje.
- Reflektor ali leča s snopom svetlobe v srednji in široki različici.
- 7W poraba energije pri 350mA.
- CRI: min. 80 / SDCM: 3
- Svetlobna učinkovitost pri 7 W:
112 lm/W (3000 K)
117 lm/W (4000 K)

SPOT FIXED REFLEKTOR

KODA PRODUKTA: 99635YZX
LED 7W 0,400kg

KODA PRODUKTA: 99636YZX
LED 2x7W 0,700kg

SPOT FIXED LEČA

KODA PRODUKTA: 99637YZX
LED 7W 0,400kg

KODA PRODUKTA: 99638YZX
LED 2x7W 0,700kg

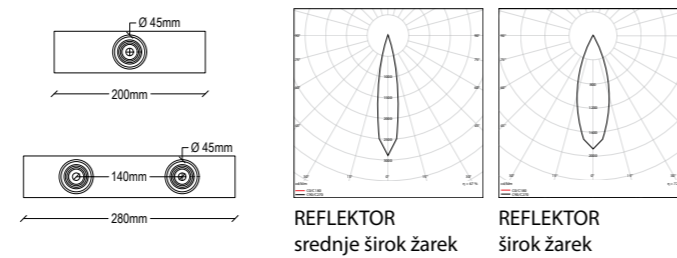
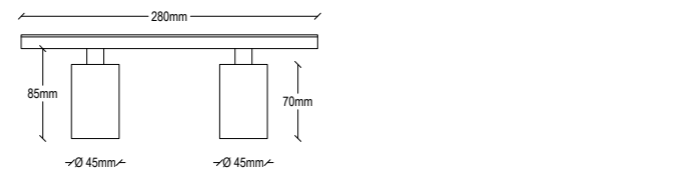
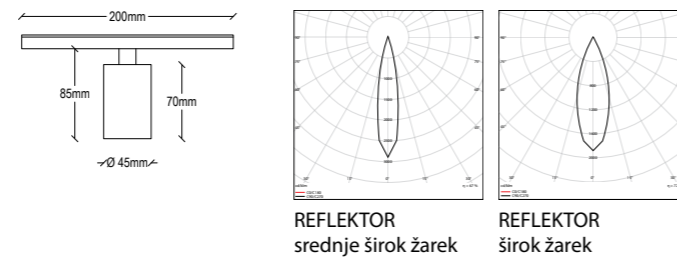

DOPOLNITEV KODE PRODUKTA:

X = BARVA

ostale barve = 0
bela = 1

titan = 2
črna = 3

Y = LED

3000K (warm) = 2
4000K (neutral) = 3

Z = ŽAREK

srednje širok žarek = 02
širok žarek = 03

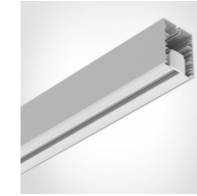

- Aluminijasti profil.
- Vključena 3-fazna tračnica.

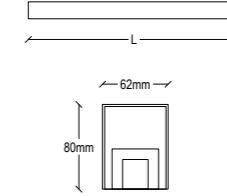

EASYLINE 3-FAZNA TRAČNICA

KODA PRODUKTA: 99641050X
L 500mm 1,600kg

KODA PRODUKTA: 99641100X
L 1000mm 3,000kg

KODA PRODUKTA: 99641150X
L 1500mm 4,600kg

KODA PRODUKTA: 99641200X
L 2000mm 6,000kg

KODA PRODUKTA: 99641300X
L 3000mm 9,000kg



- Aluminijasti profil.
- WW leče iz PMMA
- CRI: min. 80 / SDCM: 3

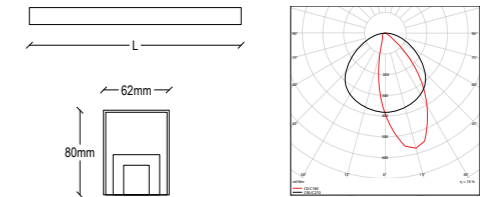

EASYLINE WW

KODA PRODUKTA: 99670204X_
LED 3000K 16W 2010lm 126 lm/W L 620mm 1,850kg

KODA PRODUKTA: 99670304X_
LED 4000K 16W 2050lm 131 lm/W L 620mm 1,850kg

KODA PRODUKTA: 99671204X_
LED 3000K 24W 3000lm 126 lm/W L 900mm 2,700kg

KODA PRODUKTA: 99671304X_
LED 4000K 24W 3100lm 131 lm/W L 900mm 2,700kg

KODA PRODUKTA: 99672204X_
LED 3000K 32W 4000lm 126 lm/W L 1180mm 3,600kg

KODA PRODUKTA: 99672304X_
LED 4000K 32W 4150lm 131 lm/W L 1180mm 3,600kg

KODA PRODUKTA: 99673204X_
LED 3000K 40W 5000lm 126 lm/W L 1460mm 4,400kg

KODA PRODUKTA: 99673304X_
LED 4000K 40W 5200lm 131 lm/W L 1460mm 4,400kg

KODA PRODUKTA: 99674204X_
LED 3000K 48W 6000lm 126 lm/W L 1740mm 5,250kg

KODA PRODUKTA: 99674304X_
LED 4000K 48W 6250lm 131 lm/W L 1740mm 5,250kg

DOPOLNITEV KODE PRODUKTA:

X = BARVA

ostale barve = 0
bela = 1

titan = 2
črna = 3

_ = D (dimmer)

Za svetilo z možnostjo zatemnitve (dimmer) dodajte črko D na koncu kode produkta.



- PTFE kabelski konektorji.
- Trižilni kabel za standardno verzijo in petžilni kabel za dimmer verzijo.



KABELSKI SETI

KODA PRODUKTA: 996510
3x0,75mm²/m 0,200kg

KODA PRODUKTA: 996511
3x0,75mm² L 1500mm 0,280kg

KODA PRODUKTA: 996512
3x0,75mm² L 2500mm 0,380kg

KODA PRODUKTA: 996520
5x0,75mm²/m 0,230kg

KODA PRODUKTA: 996521
5x0,75mm² L 1500mm 0,300kg

KODA PRODUKTA: 996522
5x0,75mm² L 2500mm 0,440kg



- Kabel in regulatorji iz nerjavečega jekla.
- Zahtevano:
2 kosa za profil do 3m.

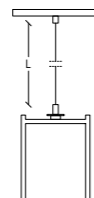

NASTAVLJIVO OBEŠALO

KODA PRODUKTA: 900112
L 1000mm 0,100kg

KODA PRODUKTA: 900114
L 2000mm 0,200kg

KODA PRODUKTA: 900116
L 3000mm 0,300kg

NASTAVLJIVO OBEŠALO ZA VERZIJO UP/DOWN

KODA PRODUKTA: 996590
L 1000mm 0,100kg

KODA PRODUKTA: 996591
L 2000mm 0,200kg

KODA PRODUKTA: 996592
L 3000mm 0,300kg



- Za viseča svetila.
- Rozeta iz aluminijastega profila s prozornim kablom.



PLATFORMA

KODA PRODUKTA: 90042X
3x0,75mm² L 2000mm Ø80 0,130kg

KODA PRODUKTA: 90043X
3x0,75mm² L 2000mm Ø70 0,130kg

KODA PRODUKTA: 90048X
5x0,50mm² L 2000mm Ø100 0,250kg



- Za viseča svetila.
- Rozeta iz aluminijastega profila s prozornim kablom.



PLATFORMA

KODA PRODUKTA: 90044X
3x0,75mm² L 2000mm 80x80 0,210kg

KODA PRODUKTA: 90045X
3x0,75mm² L 2000mm 70x70 0,200kg

KODA PRODUKTA: 90049X
5x0,50mm² L 2000mm 100x100 0,300kg

DOPOLNITEV KODE PRODUKTA:

X = BARVA

ostale barve = 0

bela = 1

titan = 2

črna = 3

EASYLINE

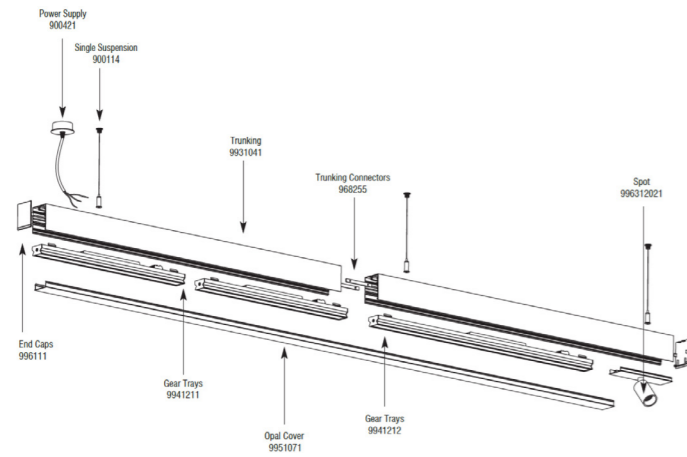

ORDER EXAMPLE

Suspension	Power Supply	Trunking	End Caps	Trunking Connectors	Gear Tray	Gear Tray	Opal Cover	Spot
CODE	CODE	CODE	CODE	CODE	CODE	CODE	CODE	CODE
900114 (3pcs)	900421 (1pc)	9931041 (2pcs)	996111 (1pc)	968255 (1pc)	9941211 (2pcs)	9941212 (1pc)	9951071 (1pc)	99631021 (1pc)

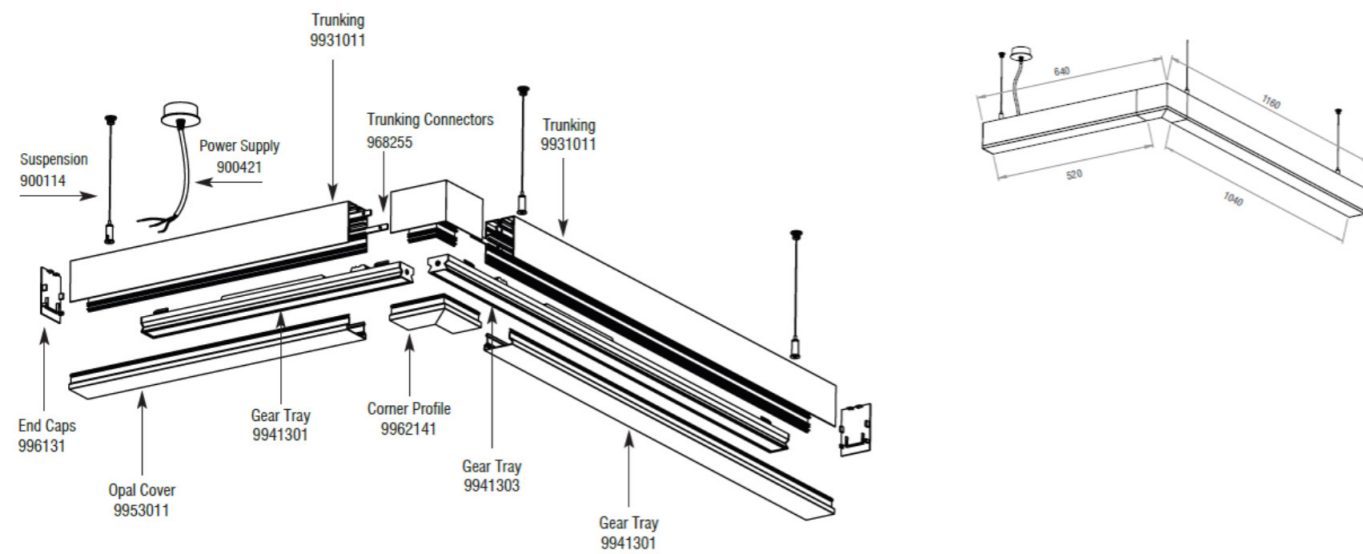

ORDER EXAMPLE

Suspension	Power Supply	Trunking	End Caps	Trunking Connectors	Gear Tray	Gear Tray	Anaglyph Cover	Corner Profile
CODE	CODE	CODE	CODE	CODE	CODE	CODE	CODE	CODE
900114 (3pcs)	900421 (1pc)	9931011 (0,52+1,04m)*	996131 (1pc)	968255 (2pc)	9941301 (1pc)	9941303 (1pc)	9953011 (0,52+1,04m)*	9962141 (1pc)

* In order to achieve a lighting corner please order Trunking & cover with code in meters





EASYLINE TRIM / TRIMLESS

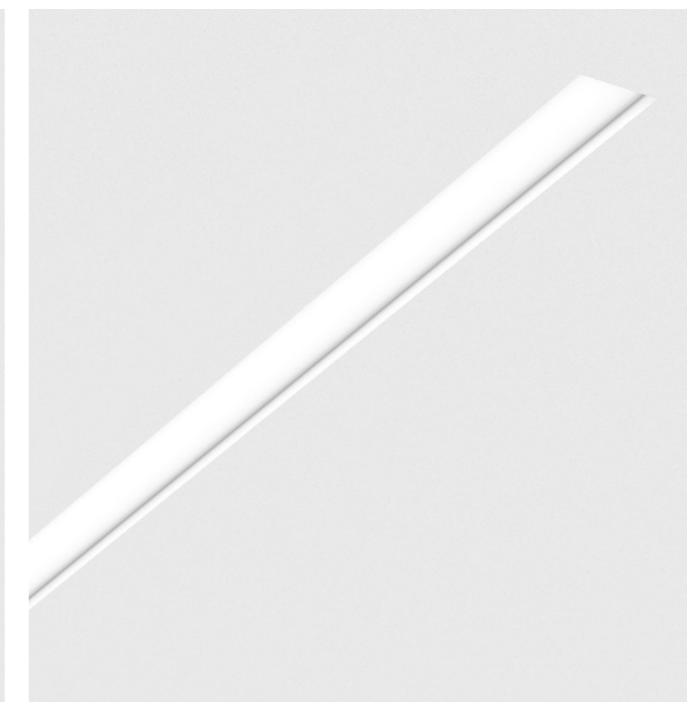
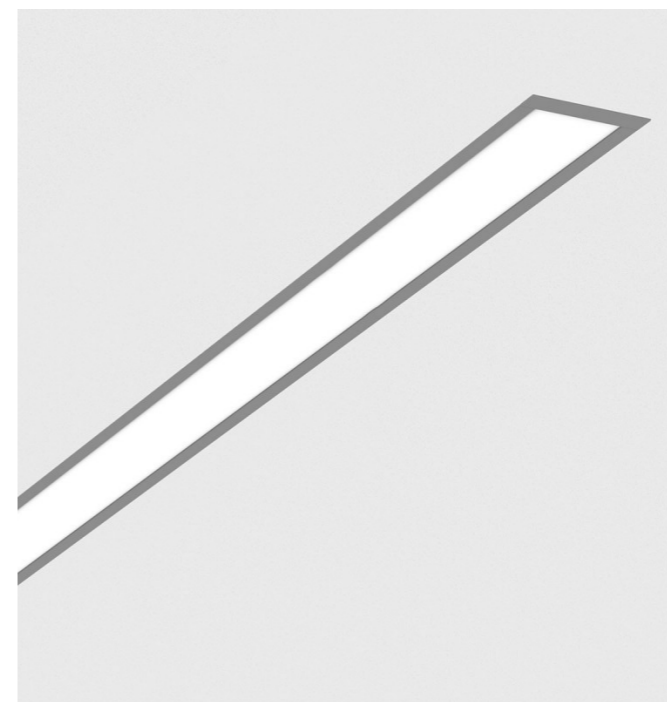

EASYLINE TRIM in EASYLINE TRIMLESS sta svetili, ki ju odlikuje učinkovitost ter sodoben izgled. Ustvarjata popolne svetlobne pogoje brez neprijetnih odsevov in sta zato primerno za uporabo od vhodnih prostorov do pisarn. Zaradi sistema nizanja (continuous-row system) je osvetljenost popolnoma enakomerna od začetka do konca. Svetili sta ekonomsko učinkoviti, ne potrebujeata vzdrževanja in imata dolgo trajno življenjsko dobo.

TEHNIČNI PODATKI IN LASTNOSTI

- Ohišje iz aluminijastega profila, lakirano elektrostatskično v izbrani barvi.
- PMMA difuzor v opalu, mikroprizmatični, mikroprizmatični opal, v anaglifni izdaji ali z barvanim aluminijastim pokrovom.
- Čista svetloba brez IR/UV sevanja.
- Učinkovito toplotno upravljanje.
- Razpon svetlobnega toka do 28 W/m in 5000 Lm.
- UGR<19 pri mikroprizmatičnih in mikroprizmatičnih različicah opala: Ocena bleščanja: X=4H/ Y=8H S=0,25H, faktor odboja 70/50/20. Za delovne postaje DSE: $\gamma \geq 650 < 3000 \text{cd/m}^2$.
- Življenjska doba delovanja: 50.000 ur z izkoristkom > 80 % začetnega svetlobnega toka (L80B10).
- Priključek za delovanje na 230V/50Hz.
- Vgradno svetilo.

NA ZAHTEVO

- Priključek za sistem zasilne razsvetljave, za eno ali tri ure.
- Na voljo z višjim indeksom barvnega upodabljanja (CRI).
- Na voljo v različici zaščite IP54.

KARAKTERISTIKE

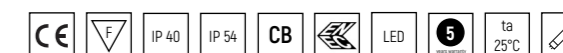

NAČIN PRITRDNITVE SVETILA



BARVE

- bela
- titan
- črna
- ostale barve

POVRŠINSKE OBDELAVE

- eloksirano

EASYLINE TRIM / TRIMLESS

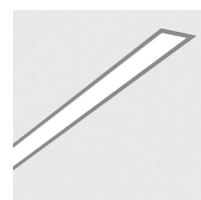

- Telo iz ekstrudiranega aluminija.
- PMMA difuzor IP40 ali IP54 v opalni, mikroprizmatični, mikroprizmatična opalni ali v anaglifni verziji ali aluminijasti pokrov pobarvan za IP40.
- CRI: min. 80 / SDCM: 3



EASYLINE TRIM

KODA PRODUKTA: 9932LX
LED 1,800kg/m



- Telo iz ekstrudiranega aluminija.
- PMMA difuzor IP40 ali IP54 v opalni, mikroprizmatični, mikroprizmatična opalni ali v anaglifni verziji ali aluminijasti pokrov pobarvan za IP40.
- CRI: min. 80 / SDCM: 3



EASYLINE TRIMLESS

KODA PRODUKTA: 9932L1
LED 2,000kg/m

DOPOLNITEV KODE PRODUKTA:

X = BARVA

ostale barve = 0 titan = 2 eloks. = 9
bela = 1 črna = 3

L = DOLŽINA ZA EASYLINE TRIM

01 = custom 03 = 864mm 05 = 1424mm 07 = 1984mm 09 = 2548mm
02 = 584mm 04 = 1144mm 06 = 1704mm 08 = 2264mm 10 = 2828mm

EASYLINE TRIM / TRIMLESS

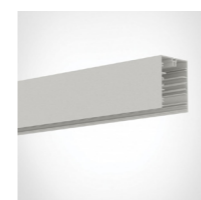

- Ohišje iz ekstrudiranega aluminija.



EASYLINE SURFACE OHIŠJE

KODA PRODUKTA: 9931LX
1,700kg



- PMMA difuzor IP40 v mikroprizmatični verziji.



EASYLINE POKROV MICROPRISMATIC

KODA PRODUKTA: 9952L1
0,250kg



- PMMA difuzor IP40 v anaglifni verziji.



EASYLINE POKROV ANAGLYPH

KODA PRODUKTA: 9953L1
0,250kg



- PMMA difuzor IP40 v opalni verziji.

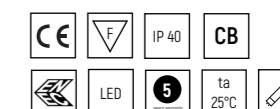

EASYLINE POKROV OPAL

KODA PRODUKTA: 9951L1
0,250kg



- PMMA difuzor IP40 v mikroprizmatični opalni verziji.

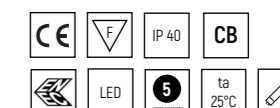

EASYLINE POKROV MICROPRISMATIC OPAL

KODA PRODUKTA: 9958L1
0,250kg



- Aluminijasti pokrov barvan za IP40.



EASYLINE ALUMINIJAST POKROV

KODA PRODUKTA: 995401X
0,500kg

L = DOLŽINA ZA EASYLINE TRIMLESS

01 = custom 03 = 900mm 05 = 1440mm 07 = 2000mm 09 = 2564mm
02 = 600mm 04 = 1160mm 06 = 1720mm 08 = 2280mm 10 = 2844mm

EASYLINE TRIM / TRIMLESS



- PMMA difuzor IP54 v opalni verziji.



EASYLINE POKROV OPAL IP54

KODA PRODUKTA: 9955L1
0,250kg



- PMMA difuzor IP54 v mikroprizmatični verziji.

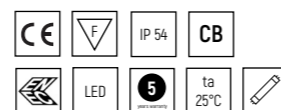

EASYLINE POKROV MICROPRISMATIC IP54

KODA PRODUKTA: 9956L1
0,250kg



- PMMA difuzor IP54 v mikroprizmatični opalni verziji.



EASYLINE POKROV MICROPRISMATIC OPAL IP54

KODA PRODUKTA: 9959L1
0,250kg



- PMMA difuzor IP54 v anaglifni verziji.

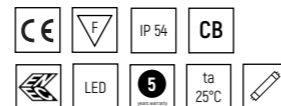

EASYLINE POKROV ANAGLYPH IP54

KODA PRODUKTA: 9957L1
0,250kg

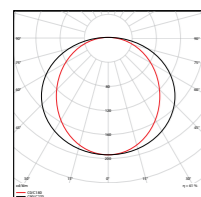

OPAL

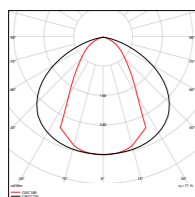

MICROPRISMATIC

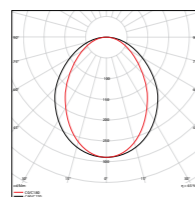

MICROPRISMATIC OPAL

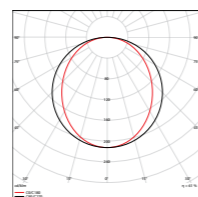

ANAGLYPH

DOPOLNITEV KODE PRODUKTA:

X = BARVA

ostale barve = 0 titan = 2 eloks. = 9
bela = 1 črna = 3

L = DOLŽINA ZA EASYLINE TRIM

01 = custom 03 = 864mm 05 = 1424mm 07 = 1984mm 09 = 2548mm
02 = 584mm 04 = 1144mm 06 = 1704mm 08 = 2264mm 10 = 2828mm

EASYLINE TRIM / TRIMLESS



- Aluminijasti pokrov.
- Količina: v paru.



EASYLINE ZAKLJUČNI POKROV TRIM

KODA PRODUKTA: 99612X
0,050kg



- Aluminijasti pokrov.
- Količina: v paru.



EASYLINE ZAKLJUČNI POKROV TRIMLESS

KODA PRODUKTA: 99617X
0,050kg



- Aluminijasti pokrov.
- Količina: v paru.



EASYLINE ZAKLJUČNI POKROV ANAGLYPH TRIM

KODA PRODUKTA: 99614X
0,050kg



- Aluminijasti pokrov.
- Količina: v paru.



EASYLINE ZAKLJUČNI POKROV ANAGLYPH TRIMLESS

KODA PRODUKTA: 99618X
0,050kg



- Aluminijasti priključki za kanale.
- Količina: v paru.



POVEZOVALNI KONEKTOR

KODA PRODUKTA: 968255

L = DOLŽINA ZA EASYLINE TRIMLESS

01 = custom 03 = 900mm 05 = 1440mm 07 = 2000mm 09 = 2564mm
02 = 600mm 04 = 1160mm 06 = 1720mm 08 = 2280mm 10 = 2844mm

EASYLINE TRIM / TRIMLESS

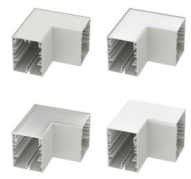

- Telo iz ekstrudiranega aluminija.
- PMMA difuzor v opalni, mikroprizmatični, mikroprizmatična opalni ali v anaglifni verziji ali barvan aluminijasti pokrov.
- CRI: min. 80 / SDCM: 3

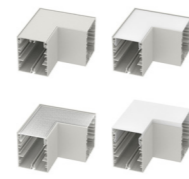

- Telo iz ekstrudiranega aluminija.
- PMMA difuzor v opalni, mikroprizmatični, mikroprizmatična opalni ali v anaglifni verziji ali barvan aluminijasti pokrov.
- CRI: min. 80 / SDCM: 3



L KONEKTOR TRIM 120x120

KODA PRODUKTA: 996221X
metal blind

KODA PRODUKTA: 996222X
opal

KODA PRODUKTA: 996223X
microprismatic

KODA PRODUKTA: 996224X
anaglyph

KODA PRODUKTA: 996225X
microprismatic opal

L KONEKTOR TRIMLESS 120x120

KODA PRODUKTA: 9962311
metal blind

KODA PRODUKTA: 9962321
opal

KODA PRODUKTA: 9962321
microprismatic

KODA PRODUKTA: 9962341
anaglyph

KODA PRODUKTA: 9962351
microprismatic opal



- Telo iz ekstrudiranega aluminijastega profila, anodiziranega.
- PMMA prozoren pokrov.
- CRI: min. 80 / SDCM: 3
- Svetlobna učinkovitost - Visoka učinkovitost: 183 lm/W (4000 K)
- 175 lm/W (3000 K)
- Svetlobna učinkovitost - Visoka moč: 174 lm/W (4000 K)
- 166 lm/W (3000 K)

- Dodatne tehnične podrobnosti:
- Enostavna namestitvev brez orodja.
 - Neprekinjene svetlobne linije brez črnih pik.
 - Na zahtevo: predhodno ožičeno za standardno, dali ali izdajo v sili.



LED MODUL - VISOKA UČINKOVITOST

KODA PRODUKTA: 994Y01
10W L 564mm

KODA PRODUKTA: 994Y02
15W L 844mm

KODA PRODUKTA: 994TY03
20W L 1124mm

KODA PRODUKTA: 994TY04
25W L 1404mm

KODA PRODUKTA: 994TY05
30W L 1684mm

KODA PRODUKTA: 994TY06
35W L 1964mm

KODA PRODUKTA: 994TY07
40W L 2244mm

*Emergency type option not possible at L564mm and L844mm

LED MODUL - VISOKA MOČ

KODA PRODUKTA: 994Y11
16W L 564mm

KODA PRODUKTA: 994Y12
24W L 844mm

KODA PRODUKTA: 994TY13
32W L 1124mm

KODA PRODUKTA: 994TY14
40W L 1404mm

KODA PRODUKTA: 994TY15
48W L 1684mm

KODA PRODUKTA: 994TY16
56W L 1964mm

KODA PRODUKTA: 994TY17
64W L 2244mm

*Emergency type option not possible at L564mm and L844mm

DOPOLNITEV KODE PRODUKTA:

- Y = LED
- 5000K (cool) = 1
 - 3000K (warm) = 2
 - 4000K (neutral) = 3
- T = TIP
- Electronic = 1
 - Dimmer = 2
 - Emergency* = 3

EASYLINE TRIM / TRIMLESS

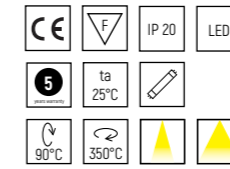

- Aluminijasto ohišje.
- Reflektor ali leča s snopom svetlobe v srednji in široki različici.
- 7W poraba energije pri 350mA.
- CRI: min. 80 / SDCM: 3
- Svetlobna učinkovitost pri 7 W: 112 lm/W (3000 K)
- 117 lm/W (4000 K)

SPOT ADJUSTABLE REFLEKTOR

KODA PRODUKTA: 99631YZX
LED 7W 0,400kg

KODA PRODUKTA: 99632YZX
LED 2x7W 0,700kg



SPOT ADJUSTABLE LEČA

KODA PRODUKTA: 99633YZX
LED 7W 0,400kg

KODA PRODUKTA: 99634YZX
LED 2x7W 0,700kg

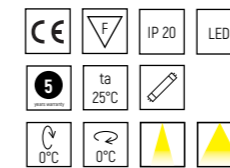
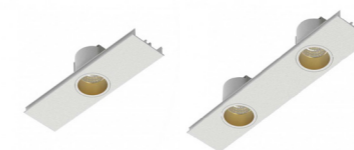
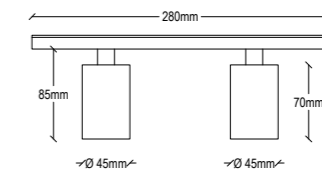

- Aluminijasto ohišje.
- Reflektor ali leča s snopom svetlobe v srednji in široki različici.
- 7W poraba energije pri 350mA.
- CRI: min. 80 / SDCM: 3
- Svetlobna učinkovitost pri 7 W: 112 lm/W (3000 K)
- 117 lm/W (4000 K)

SPOT FIXED REFLEKTOR

KODA PRODUKTA: 99635YZX
LED 7W 0,400kg

KODA PRODUKTA: 99636YZX
LED 2x7W 0,700kg

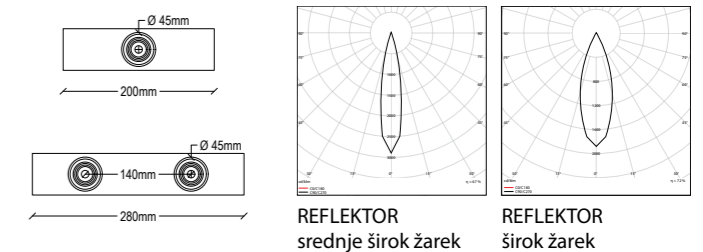

SPOT FIXED LEČA

KODA PRODUKTA: 99637YZX
LED 7W 0,400kg

KODA PRODUKTA: 99638YZX
LED 2x7W 0,700kg

DOPOLNITEV KODE PRODUKTA:

- X = BARVA
- ostale barve = 0
 - bela = 1
 - titan = 2
 - črna = 3
- Y = LED
- 3000K (warm) = 2
 - 4000K (neutral) = 3
- Z = ŽAREK
- srednje širok žarek = 02
 - širok žarek = 03

EASYLINE TRIM / TRIMLESS

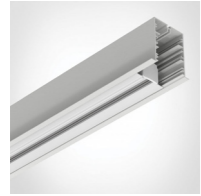

- Aluminijasti profil.
- 3-fazna tračnica vključena.

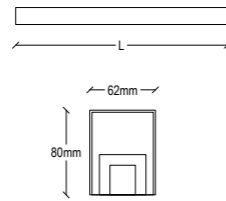

EASYLINE TRACK 3PHASE

KODA PRODUKTA: 99642050X
L 500mm 1,600kg

KODA PRODUKTA: 99642100X
L 1000mm 3,000kg

KODA PRODUKTA: 99642150X
L 1500mm 4,600kg

KODA PRODUKTA: 99642200X
L 2000mm 6,000kg

KODA PRODUKTA: 99642300X
L 3000mm 9,000kg



- Aluminijasti profil.
- WW leča iz PMMA.
- CRI: min. 80 / SDCM: 3

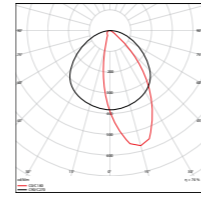
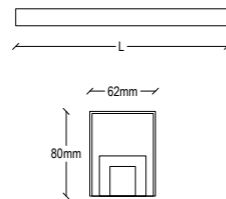

EASYLINE WW

KODA PRODUKTA: 99660204X_
LED 3000K 16W 2010lm 126 lm/W L 620mm 1,850kg

KODA PRODUKTA: 99660304X_
LED 4000K 16W 2050lm 131 lm/W L 620mm 1,850kg

KODA PRODUKTA: 99661204X_
LED 3000K 24W 3000lm 126 lm/W L 900mm 2,700kg

KODA PRODUKTA: 99661304X_
LED 4000K 24W 3100lm 131 lm/W L 900mm 2,700kg

KODA PRODUKTA: 99662204X_
LED 3000K 32W 4000lm 126 lm/W L 1180mm 3,600kg

KODA PRODUKTA: 99662304X_
LED 4000K 32W 4150lm 131 lm/W L 1180mm 3,600kg

KODA PRODUKTA: 99663204X_
LED 3000K 40W 5000lm 126 lm/W L 1460mm 4,400kg

KODA PRODUKTA: 99663304X_
LED 4000K 40W 5250lm 131 lm/W L 1460mm 4,400kg

KODA PRODUKTA: 99664204X_
LED 3000K 48W 6000lm 126 lm/W L 1740mm 5,250kg

KODA PRODUKTA: 99664304X_
LED 4000K 48W 6250lm 131 lm/W L 1740mm 5,250kg

DOPOLNITEV KODE PRODUKTA:

X = BARVA

- ostale barve = 0
- titan = 2
- bela = 1
- črna = 3

_ = D (dimmer)

Za svetilo z možnostjo zatemnitve (dimmer) dodajte črko D na koncu kode produkta.

EASYLINE TRIM / TRIMLESS



- PTFE kabelski konektorji.
- Trižilni kabel za standardno verzijo in petžilni kabel za dimmer verzijo.



KABELSKI SETI

KODA PRODUKTA: 996510
3x0,75mm²/m 0,200kg

KODA PRODUKTA: 996511
3x0,75mm² L 1500mm 0,280kg

KODA PRODUKTA: 996512
3x0,75mm² L 2500mm 0,380kg

KODA PRODUKTA: 996520
5x0,75mm²/m 0,230kg

KODA PRODUKTA: 996521
5x0,75mm² L 1500mm 0,300kg

KODA PRODUKTA: 996522
5x0,75mm² L 2500mm 0,440kg

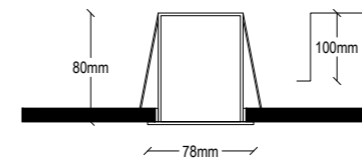

EASYLINE NOSILEC TRIM

KODA PRODUKTA: 900211
0,100kg

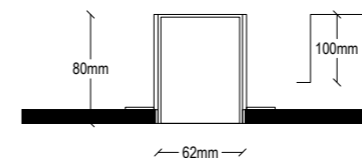
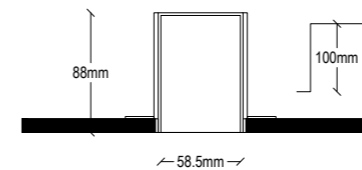

EASYLINE NOSILEC TRIMLESS & SURFACE LUMINAIRE AS TRIMLESS

KODA PRODUKTA: 900212
0,100kg

- Kovinski nosilec za TRIM izvedbo.
- Potreben 1 kos na 1 m dolžine profila.



- Kovinski nosilec namenjen za stropno TRIM izvedbo.
- Potreben 1 kos na 1 m dolžine profila.





EASYLINE APPLIQUE



EASYLINE APPLIQUE svetilka združuje učinkovitost s sodobnim dizajnom. Ustvarja popolne svetlobne pogoje brez neprijetnih odsevov in je zato primerno za uporabo od vhodnih prostorov do pisarn. Zaradi sistema nizanja (continuous-row system) je osvetljenost popolnoma enakomerna od začetka do konca. Svetilo je ekonomsko učinkovito, ne potrebuje vzdrževanja in ima dolgo trajno življenjsko dobo.

TEHNIČNI PODATKI IN LASTNOSTI

- Aluminijasto ohišje, prašno barvano v izbrani barvi.
- PMMA difuzor v opalu.
- Odstranljive plastične glave.
- Čista svetloba brez IR/UV sevanja.
- Učinkovito toplotno upravljanje.
- Razpon svetlobnega toka do 28 W/m in 5000 lm.
- Življenjska doba delovanja: 50.000 ur z izkoristkom > 80% začetnega svetlobnega toka (L80B10).
- Priključek za delovanje na 230V-50/60Hz.

NA ZAHTEVO

- Priključek za sistem zasilne razsvetljave, za eno ali tri ure.
- Mikroprizmatični ali anaglifni difuzor.
- Na voljo z višjim indeksom barvnega upodabljanja (CRI).

KARAKTERISTIKE



NAČIN PRITRDNITVE SVETILA



BARVE

- bela
- titan
- črna
- ostale barve

POVRŠINSKE OBDELAVE

- eloksirano

EASYLINE APPLIQUE



- Aluminijasto ohišje.
- Odstranljive plastične glave.
- Visoko učinkovit PMMA difuzor v opalu.
- CRI: min. 80 / SDCM: 3



EASYLINE APPLIQUE

KODA PRODUKTA: 990621X_
LED 3000K 15W 175 lm/W L 870mm 2,900kg

KODA PRODUKTA: 990631X_
LED 4000K 15W 183 lm/W L 870mm 2,900kg

KODA PRODUKTA: 990622X_
LED 3000K 20W 175 lm/W L 1150mm 4,000kg

KODA PRODUKTA: 990632X_
LED 4000K 20W 183 lm/W L 1150mm 4,000kg

KODA PRODUKTA: 990623X_
LED 3000K 25W 175 lm/W L 1430mm 5,000kg

KODA PRODUKTA: 990633X_
LED 4000K 25W 183 lm/W L 1430mm 5,000kg

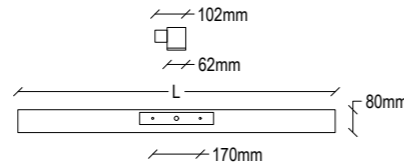

- Aluminijasto ohišje.
- Odstranljive plastične glave.
- Visoko učinkovit PMMA difuzor v opalu.
- CRI: min. 80 / SDCM: 3



EASYLINE SURFACE APPLIQUE

KODA PRODUKTA: 990721X_
LED 3000K 15W 175 lm/W L 870mm 2,900kg

KODA PRODUKTA: 990731X_
LED 4000K 15W 183 lm/W L 870mm 2,900kg

KODA PRODUKTA: 990722X_
LED 3000K 20W 175 lm/W L 1150mm 4,000kg

KODA PRODUKTA: 990732X_
LED 4000K 20W 183 lm/W L 1150mm 4,000kg

KODA PRODUKTA: 990723X_
LED 3000K 25W 175 lm/W L 1430mm 5,000kg

KODA PRODUKTA: 990733X_
LED 4000K 25W 183 lm/W L 1430mm 5,000kg

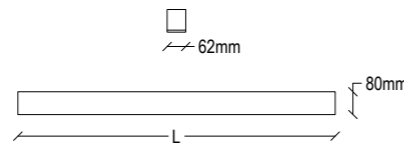

DOPOLNITEV KODE PRODUKTA:

X = BARVA

ostale barve = 0 titan = 2
bela = 1 črna = 3

_ = D (dimmer)

Za svetilo z možnostjo zatemnitve (dimmer) dodajte črko D na koncu kode produkta.

EASYLINE APPLIQUE



- Aluminijasto ohišje.
- Odstranljive plastične glave.
- Visoko učinkovit PMMA difuzor v opalu.
- CRI: min. 80 / SDCM: 3

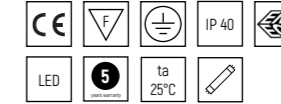

EASYLINE APPLIQUE UP/DOWN

KODA PRODUKTA: 990421X_
LED 3000K 15W+15W 175 lm/W L 870mm 3,100kg

KODA PRODUKTA: 990431X_
LED 4000K 15W+15W 183 lm/W L 870mm 3,100kg

KODA PRODUKTA: 990422X_
LED 3000K 20W+20W 175 lm/W L 1150mm 4,200kg

KODA PRODUKTA: 990432X_
LED 4000K 20W+20W 183 lm/W L 1150mm 4,200kg

KODA PRODUKTA: 990423X_
LED 3000K 25W+25W 175 lm/W L 1430mm 5,300kg

KODA PRODUKTA: 990433X_
LED 4000K 25W+25W 183 lm/W L 1430mm 5,300kg

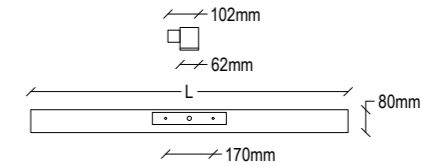

- Aluminijasto ohišje.
- Odstranljive plastične glave.
- Visoko učinkovit PMMA difuzor v opalu.
- CRI: min. 80 / SDCM: 3



EASYLINE SURFACE APPLIQUE UP/DOWN

KODA PRODUKTA: 990521X_
LED 3000K 15W+15W 175 lm/W L 870mm 3,100kg

KODA PRODUKTA: 990531X_
LED 4000K 15W+15W 183 lm/W L 870mm 3,100kg

KODA PRODUKTA: 990522X_
LED 3000K 20W+20W 175 lm/W L 1150mm 4,200kg

KODA PRODUKTA: 990532X_
LED 4000K 20W+20W 183 lm/W L 1150mm 4,200kg

KODA PRODUKTA: 990523X_
LED 3000K 25W+25W 175 lm/W L 1430mm 5,300kg

KODA PRODUKTA: 990533X_
LED 4000K 25W+25W 183 lm/W L 1430mm 5,300kg

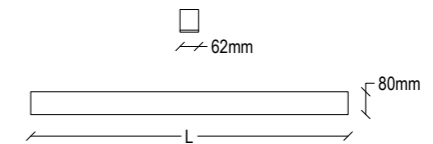

DOPOLNITEV KODE PRODUKTA:

X = BARVA

ostale barve = 0 titan = 2
bela = 1 črna = 3

_ = D (dimmer)

Za svetilo z možnostjo zatemnitve (dimmer) dodajte črko D na koncu kode produkta.



LUMENIA d.o.o.
Kandrše 7, 1252 Vače, Slovenija

TEL: +386 3 567 07 96
E-MAIL: info@lumenia.com
www.lumenia.com